

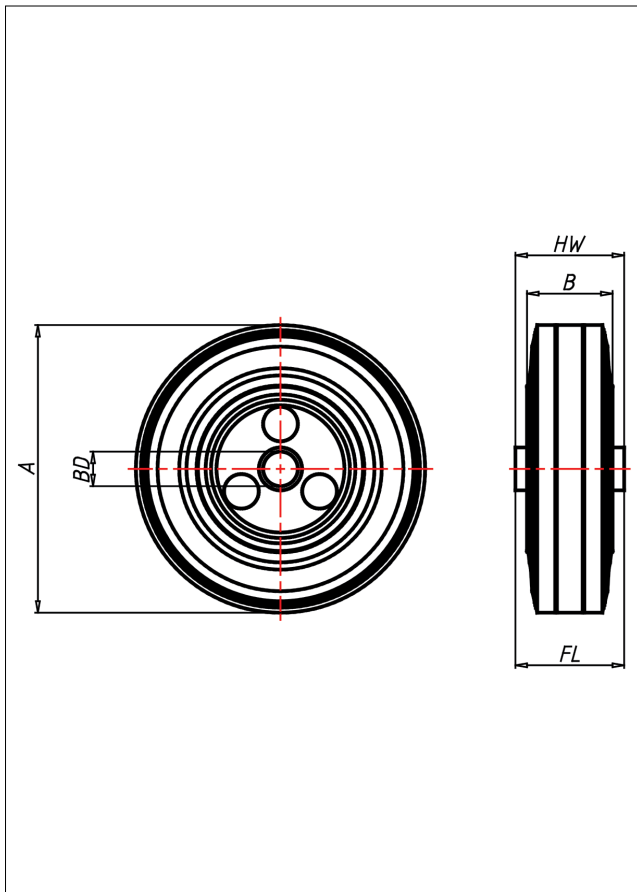

HB
Hitzefest

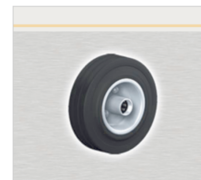

HB Hitzefest



Verschraubte Stahlblechfelge, verzinkt oder Edelstahl
Vollgummireifen schwarz, hitzebeständig

- hitzebeständig
- geräuscharmer Lauf
- großer Fahrkomfort
- beständig gegen verdünnte Säuren

Technische Details

ORDERNO (Artikel-nummer)	100 HBX 10
WDAB (Rad-Ø A x Breite B)	100x30
LC (Tragkraft / kg)	70
HW (Nabellänge / mm)	40
FL (Einbaulänge / mm)	40
WB (Radlager)	Edelstahl-Rollenlager
BD (Bohrungsdurchmesser / mm)	10