

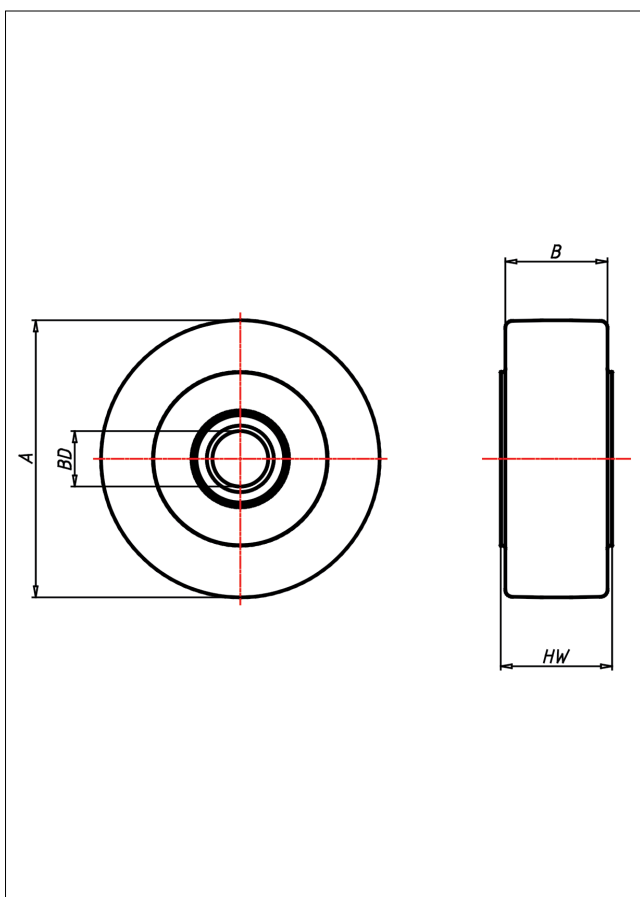

PE Rad

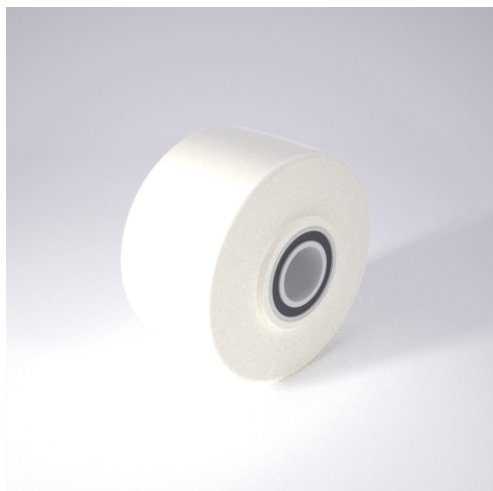

PE



+80 °C
-40 °C max.
12000 kg

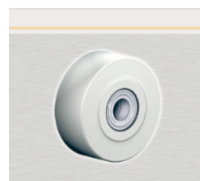

Vollrad aus Guss-Polyamid 6 - 1. Wahl

- für extra schwere Lasten
- leichter Lauf auf glatten Böden
- stoß- und schlagfest
- hohe Abriebfestigkeit
- leicht zu reinigen
- sehr beständig gegen viele aggressive Medien

Technische Details

ORDERNO (Artikel-nummer)	100 PEK 20
WDAB (Rad-Ø A x Breite B / mm)	100x40
LC (Tragkraft / kg)	1200
HW (Nabellänge / mm)	45
FL (Einbaulänge / mm)	45
WB (Radlager)	2 Rillen-Kugellager 6304 2RS
BD (Bohrungsdurchmesser / mm)	20