

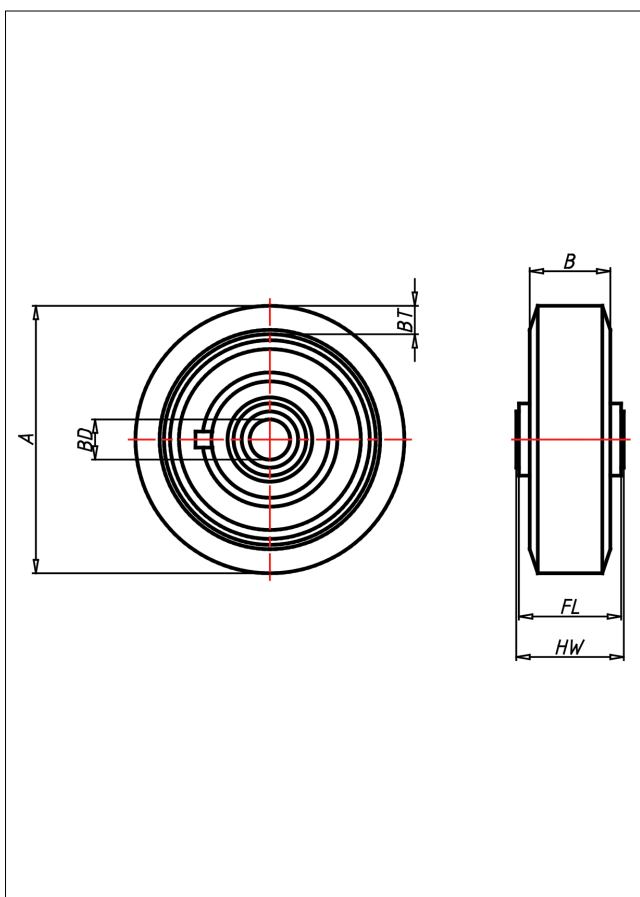

A Rad

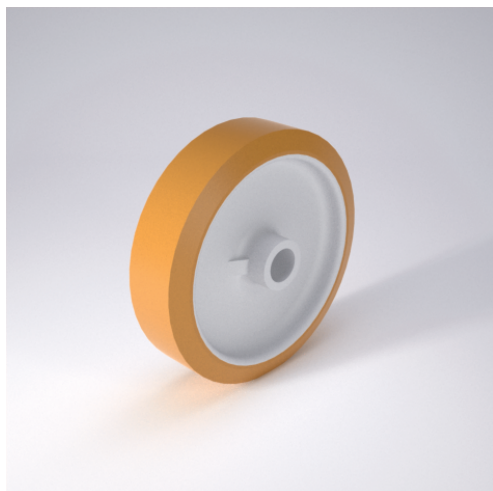

A

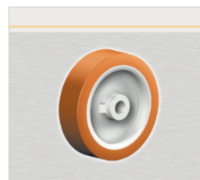

Radkörper aus Polyamid 6 - 1. Wahl
Laufbelag aus Guss-Polyurethan, 95±3 Shore A

- geräuscharmer Lauf
- geringer Rollwiderstand
- abrieb- und reißfest
- hohe Stoßfestigkeit
- leichte Reinigung
- sehr beständig gegen viele aggressive Medien

Technische Details

ORDERNO (Artikel-nummer)	101 ABX 15
WDAB (Rad-Ø A x Breite B / mm)	100x40
LC (Tragkraft / kg)	250
BT (Reifenstärke / mm)	10
HW (Nabellänge / mm)	40
FL (Einbaulänge / mm)	40
WB (Radlager)	INOX-Rollenlager
BD (Bohrungsdurchmesser / mm)	15