

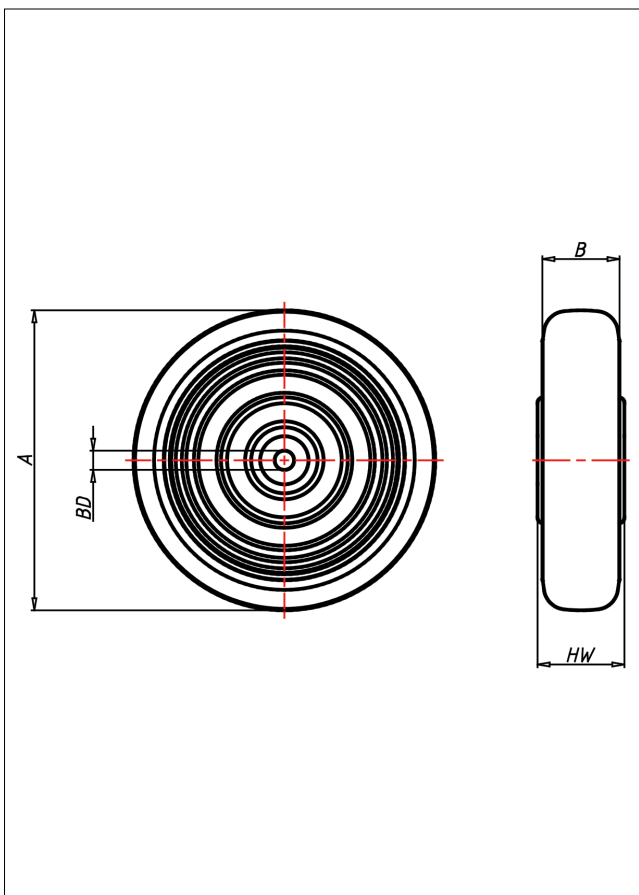

# AEL Rad

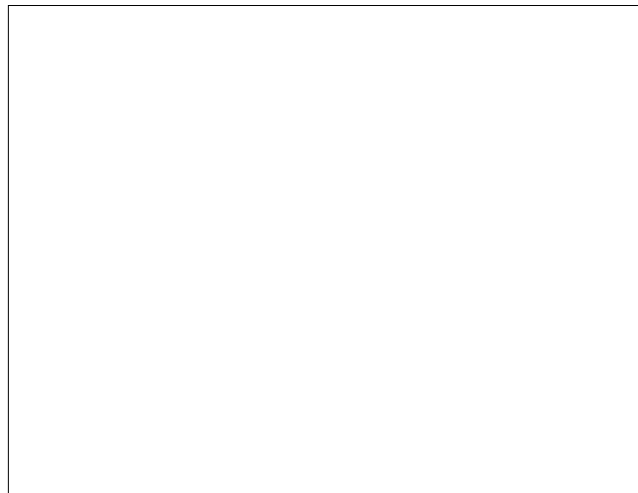

AEL

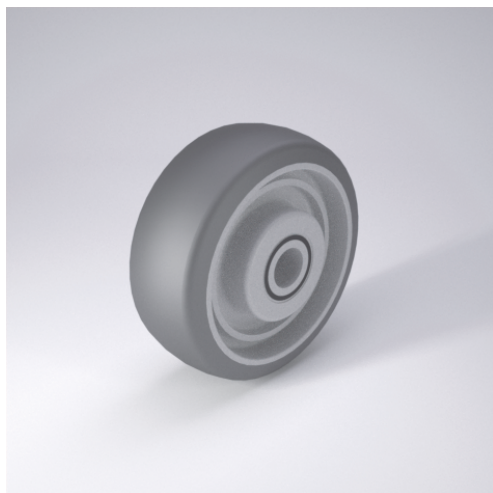

Radkörper aus Polyamid 6 - 1. Wahl  
Laufbelag aus Polyurethan, 90±3 Shore A  
elektrisch leitfähig

- elektrisch leitfähig
- geräuscharmer Lauf
- geringer Rollwiderstand
- spurfrei
- hohe Stoßfestigkeit
- sehr beständig gegen viele aggressive Medien

### Technische Details

<b>ORDERNO (Artikel-nummer)</b>	125 AELK 20
<b>WDAB (Rad-Ø A x Breite B / mm)</b>	125x46
<b>LC (Tragkraft / kg)</b>	400
<b>HW (Nabellänge / mm)</b>	50
<b>FL (Einbaulänge / mm)</b>	50
<b>WB (Radlager)</b>	2 Rillen-Kugellager 6204 2RS
<b>BD (Bohrungsdurchmesser / mm)</b>	20