

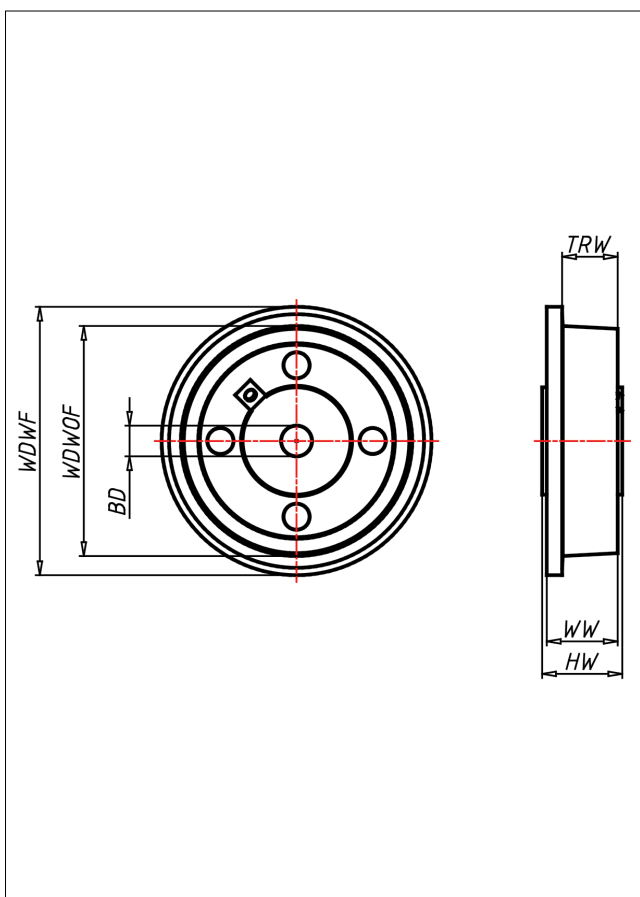

# SP Spurkranzrad

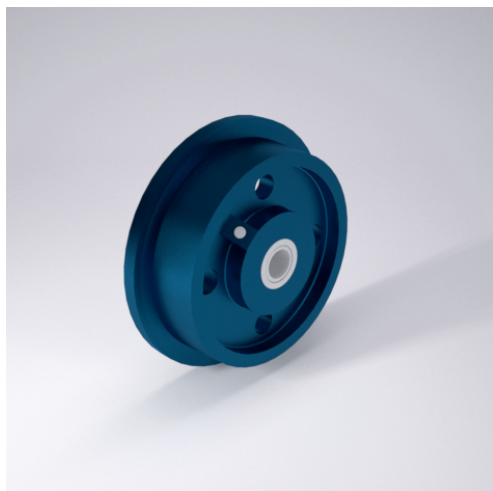

## SP Spurkranzrad



+300 °C\*  
-40 °C max.  
3000 kg



Spurkranzrad aus Eisenguss  
Lauffläche sauber überdreht, Neigungswinkel 3°  
Ausführung lackiert

- sehr hohe Tragkraft
- sehr abriebfest
- für hohe Temperaturen

## Technische Details

ORDERNO (Artikel-nummer)	125 SP-20
WDWOF (Rad-Ø o. Spurkranz / mm)	125
WDWF (Rad-Ø m. Spurkranz / mm)	145
TRW (Laufflächenbreite / mm)	36
WW (Radbreite / mm)	46
LC (Tragkraft / kg)	900
HW (Nabellänge / mm)	52
WB (Radlager)	Gleitlager
BD (Bohrungsdurchmesser / mm)	20