

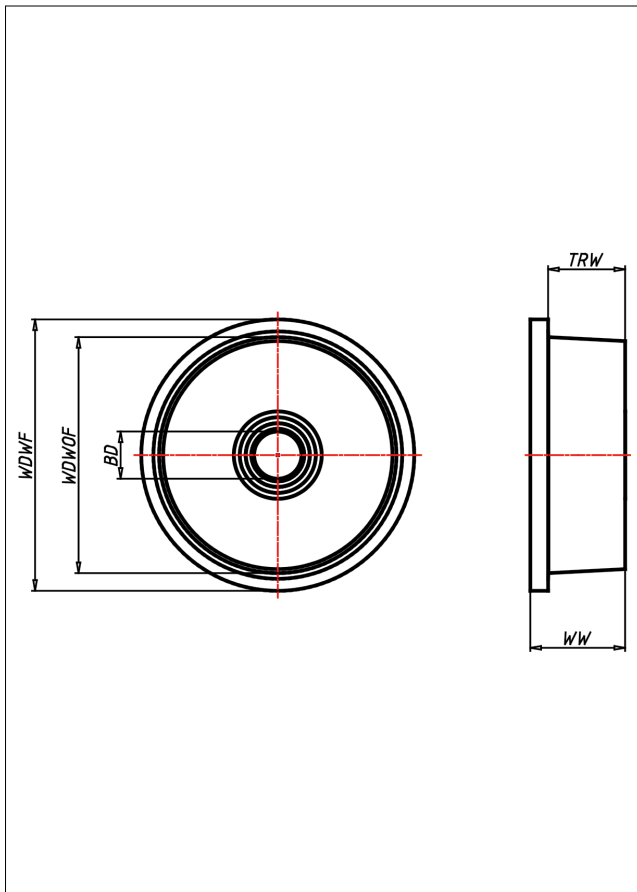

SPE

Spurkranzrad

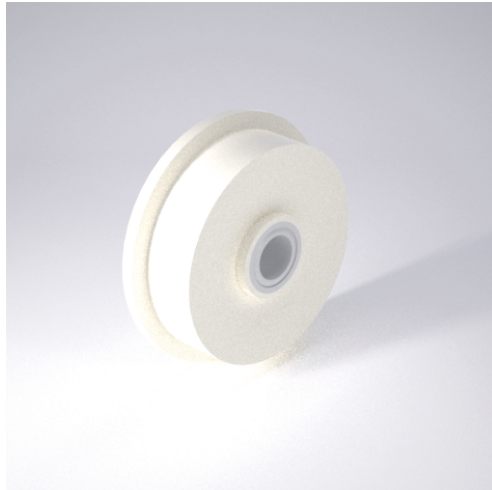

SPE Spurkranzrad



Spurkranzrad aus hochverdichtetem, zähhartem Gusspolyamid, aus Vollmaterial gedreht
Lauffläche 3° ansteigend

- geringer Rollwiderstand
- hohe Abriebfestigkeit
- sehr hohe Tragkraft

Technische Details

ORDERNO (Artikel-nummer)	125 SPEK 20
WDWOF (Rad-Ø o. Spurkranz / mm)	125
WDFW (Rad-Ø m. Spurkranz / mm)	145
TRW (Laufflächenbreite / mm)	36
WW (Radbreite / mm)	46
LC (Tragkraft / kg)	1500
HW (Nabellänge / mm)	46
WB (Radlager)	2 Rillen-Kugellager ZZ
BD (Bohrungsdurchmesser / mm)	20