

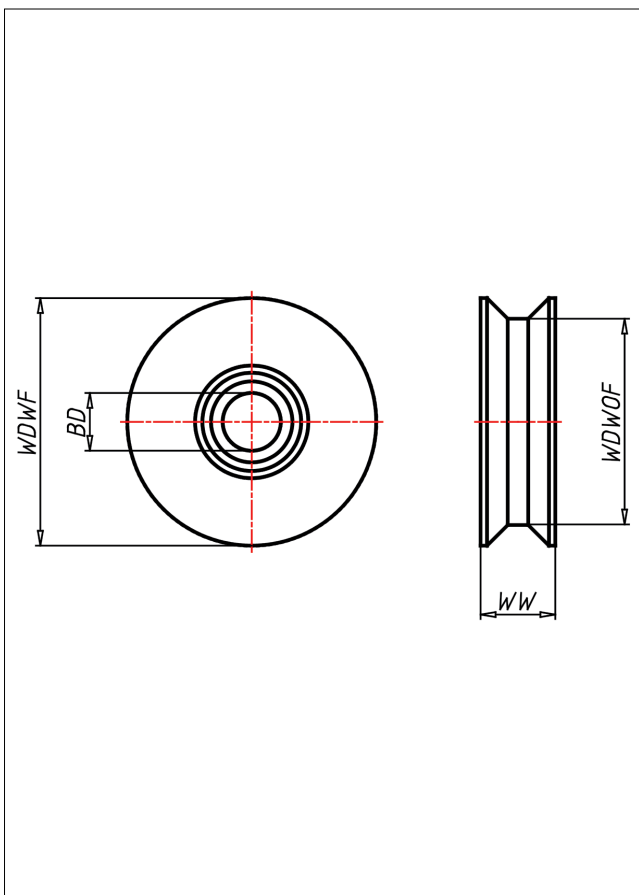

SVT V-Nutrad

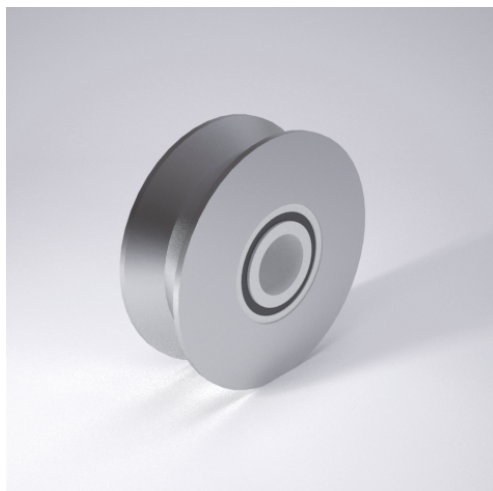

SVT V-Nutrad

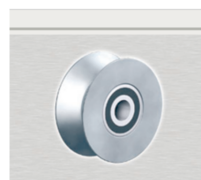

90° V-Nut Rad aus Stahl BS970

- sehr hohe Tragkraft
- sehr abriebfest
- für hohe Temperaturen

Technische Details

ORDERNO (Artikel-nummer)	125 SVT-25
WDWOF (Rad-Ø o. Spurkranz / mm)	100
WDWF (Rad-Ø m. Spurkranz / mm)	125
WW (Radbreite / mm)	40
LC (Tragkraft / kg)	1560
HW (Nabenlänge / mm)	40
WB (Radlager)	Bohrung mit Keilnut
BD (Bohrungsdurchmesser / mm)	25 H7