

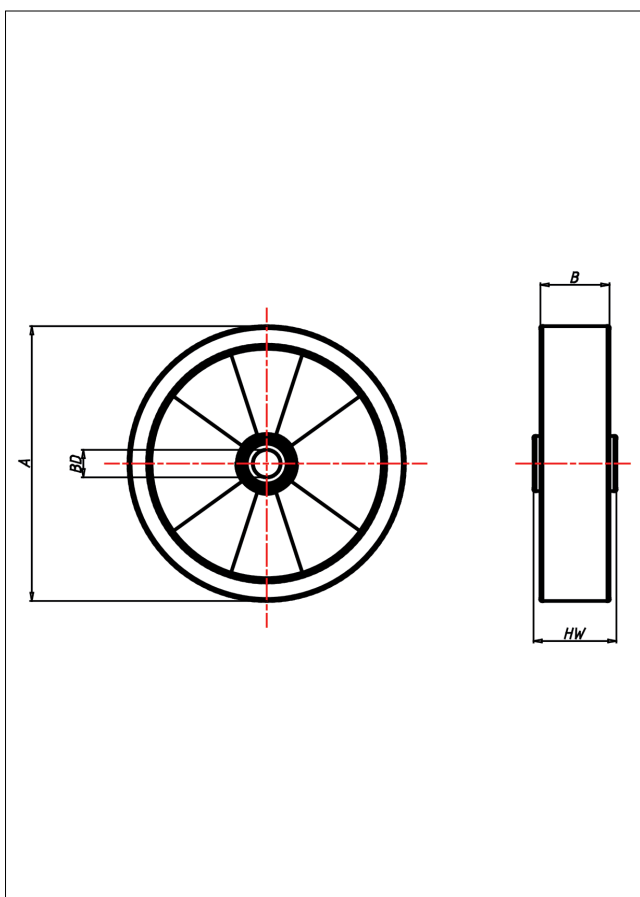

TLEL Rad

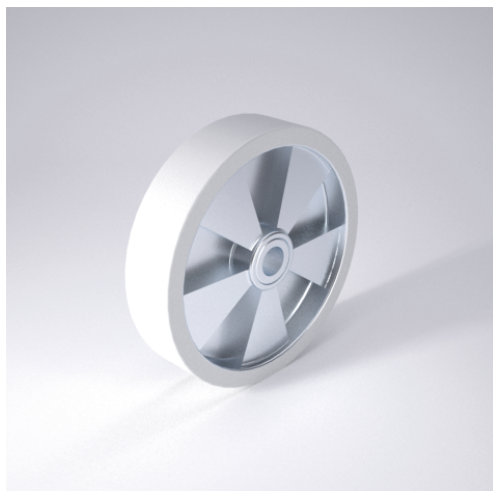

TLEL



Radkörper aus Spritzguss-Aluminium-Legierung
Laufbelag aus Guss-Polyurethan 95:3 Shore A
Elektrisch leitfähig

- elektrisch leitfähig
- geräuscharmer Lauf
- geringer Rollwiderstand
- abrieb- und reißfest
- spurfrei
- sehr beständig gegen viele aggressive Medien

Technische Details

ORDERNO (Artikel-nummer)	125 TLELK 15
WDAB (Rad-Ø A x Breite B / mm)	125x30
LC (Tragkraft / kg)	250
HW (Nabellänge / mm)	30
FL (Einbaulänge / mm)	30
WB (Radlager)	2 Rillen-Kugellager 6202 ZZ
BD (Bohrungsdurchmesser / mm)	15