

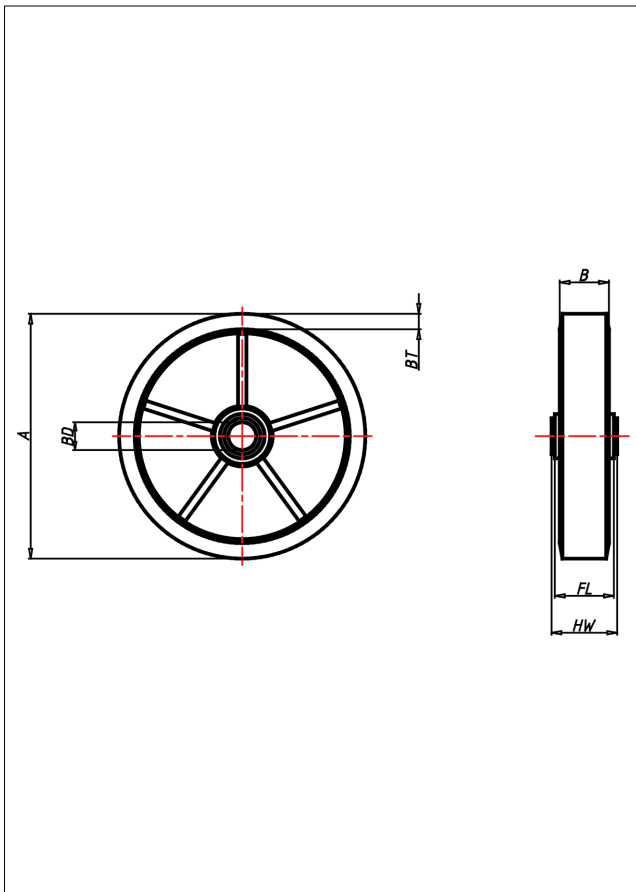

# Z/SU Rad



## Z/SU



**Z**

Radkörper aus Gusseisen lackiert  
Laufbelag aus Guss-Polyurethan 95±3 Shore A

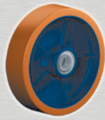

- geräuscharmer Lauf
- geringer Rollwiderstand
- abrieb- und reißfest
- hohe Stoßfestigkeit
- sehr beständig gegen viele aggressive Medien

## Technische Details

<b>ORDERNO (Artikel-nummer)</b>	125 ZK 15
<b>WDAB (Rad-Ø A x Breite B / mm)</b>	125x30
<b>LC (Tragkraft / kg)</b>	330
<b>BT (Reifenstärke / mm)</b>	14
<b>HW (Nabellänge / mm)</b>	40
<b>FL (Einbaulänge / mm)</b>	38
<b>WB (Radlager)</b>	2 Rillen-Kugellager 6202 ZZ
<b>BD (Bohrungsdurchmesser / mm)</b>	15