

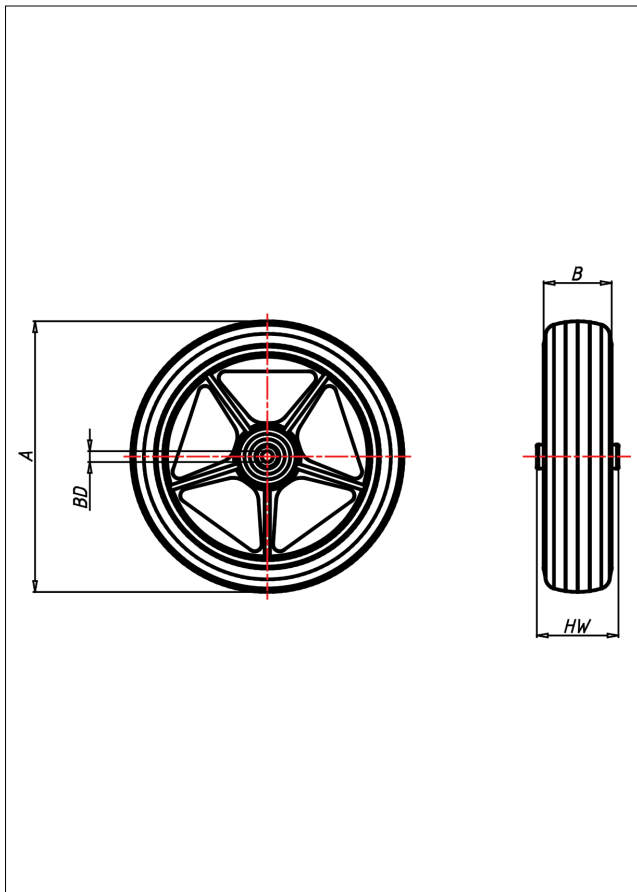

PU Rad



PU Rollstuhlräder



Radkörper aus Polyamid 6 - 1. Wahl
Polyurethan-Reifen, grau

- pannensicher
- spurfrei
- geräuscharmer Lauf
- geringer Rollwiderstand
- abriebfest
- sehr beständig gegen viele aggressive Medien

Technische Details

| | |
|---------------------------------------|---------------------|
| ORDERNO (Artikel-nummer) | 150 PUK 8 |
| WDAB (Rad-Ø A x Breite B / mm) | 150x32 |
| LC (Tragkraft / kg) | 50 |
| HW (Nabellänge / mm) | 36 |
| FL (Einbaulänge / mm) | 36 |
| WB (Radlager) | 2 Rillen-Kugellager |
| BD (Bohrungsdurchmesser / mm) | 8 |