

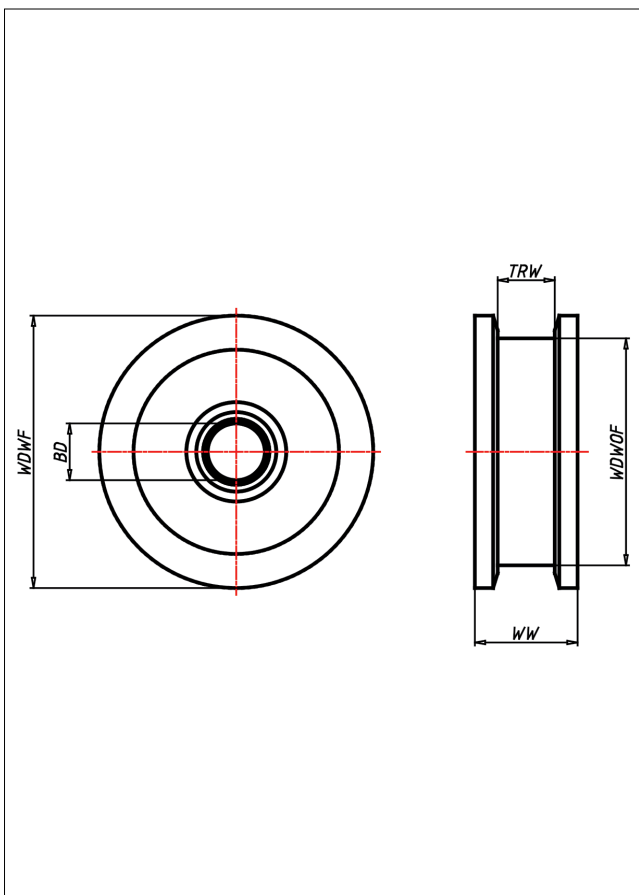

SDF

Doppel-Spurkranzrad



SDF Doppel-Spurkranzrad

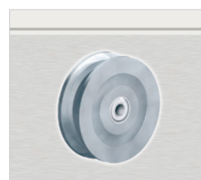

Doppel-Spurkranzrad aus Stahl BS 970
Lauffläche sauber überdreht

- sehr hohe Tragkraft
- sehr abriebfest
- für hohe Temperaturen

Technische Details

ORDERNO (Artikel-nummer)	150 SDF-30
WDWOF (Rad-Ø o. Spurkranz / mm)	150
WDWF (Rad-Ø m. Spurkranz / mm)	190
TRW (Laufflächenbreite / mm)	50
WW (Radbreite / mm)	80
LC (Tragkraft / kg)	4200
HW (Nabellänge / mm)	80
WB (Radlager)	Bohrung mit Keilnut
BD (Bohrungsdurchmesser / mm)	30 H7