

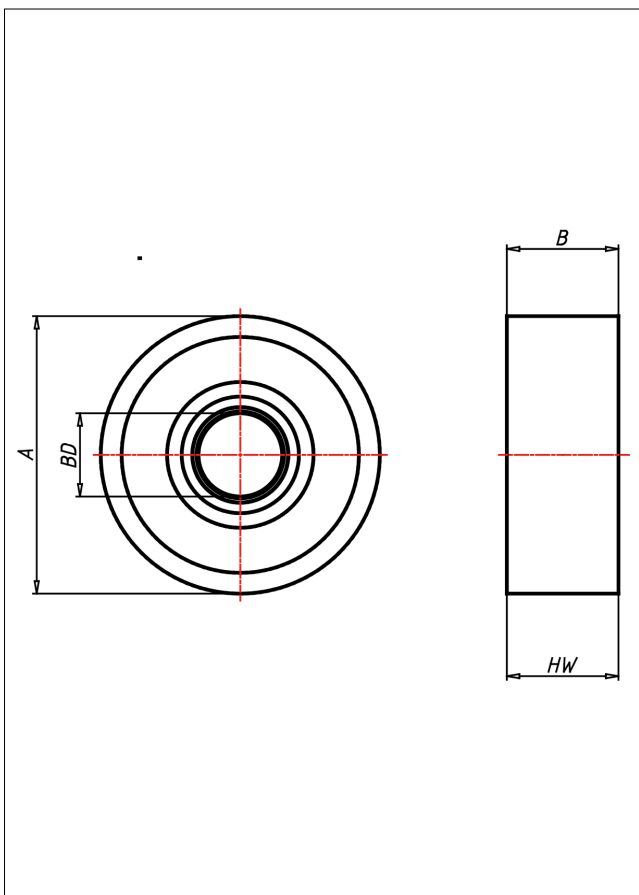

SFT Schienenrad

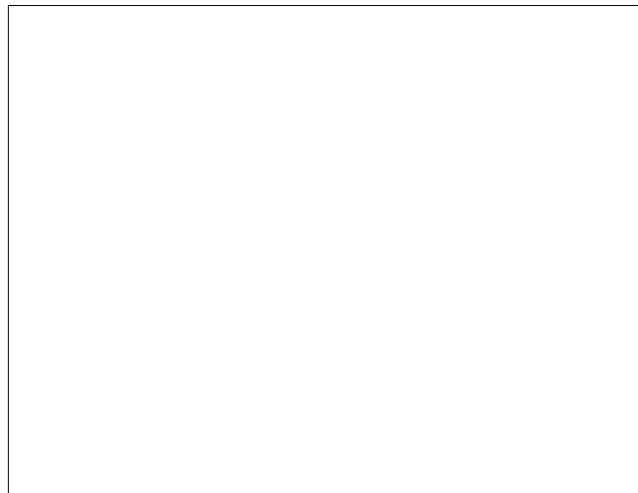

SFT Schienenrad

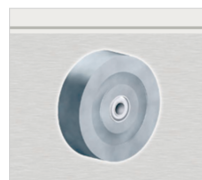

Schienenrad aus Stahl BS 970
Lauffläche sauber überdreht

- sehr hohe Tragkraft
- sehr abriebfest
- für hohe Temperaturen

Technische Details

ORDERNO (Artikel-nummer)	150 SFTTM 40
WDAB (Rad-Ø A x Breite B / mm)	150x80
LC (Tragkraft / kg)	6700
HW (Nabellänge / mm)	80
WB (Radlager)	Schräggrollenlager
BD (Bohrungsdurchmesser / mm)	40