

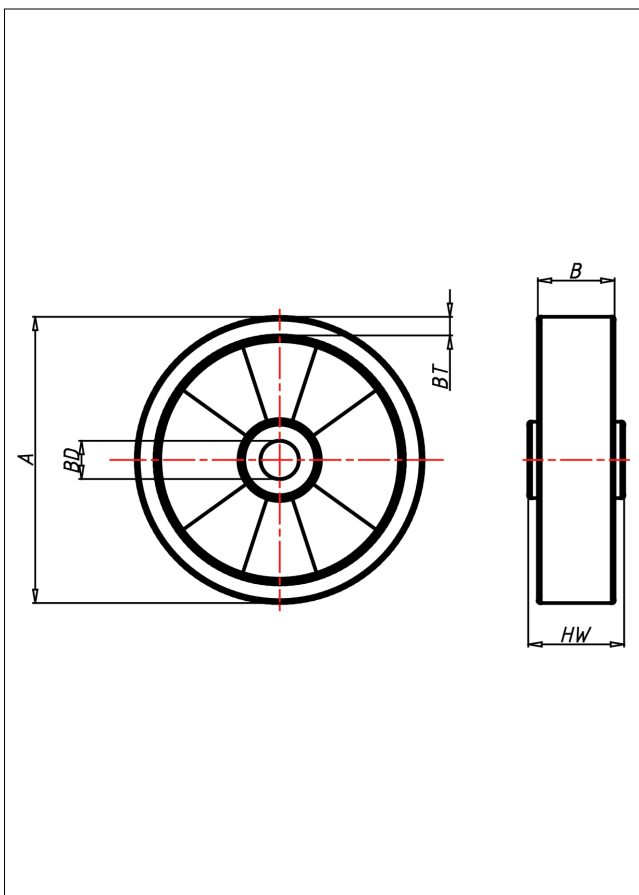

TL
Rad

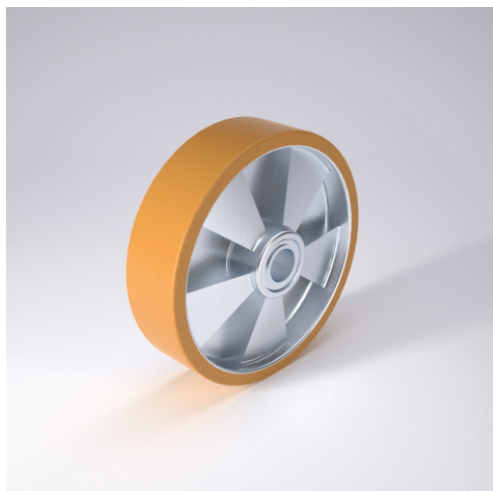

TL



Radkörper aus Spritzguss-Aluminium-Legierung
Laufbelag aus Guss-Polyurethan 95E3 Shore A

- geräuscharmer Lauf
- geringer Rollwiderstand
- abrieb- und reißfest
- hohe Stoßfestigkeit
- sehr beständig gegen viele aggressive Medien

Technische Details

ORDERNO (Artikel-nummer)	150 TLK 20
WDAB (Rad-Ø A x Breite B / mm)	150x40
LC (Tragkraft / kg)	400
BT (Reifenstärke / mm)	8
HW (Nabellänge / mm)	50
FL (Einbaulänge / mm)	48
WB (Radlager)	2 Rillen-Kugellager 6204 ZZ
BD (Bohrungsdurchmesser / mm)	20