

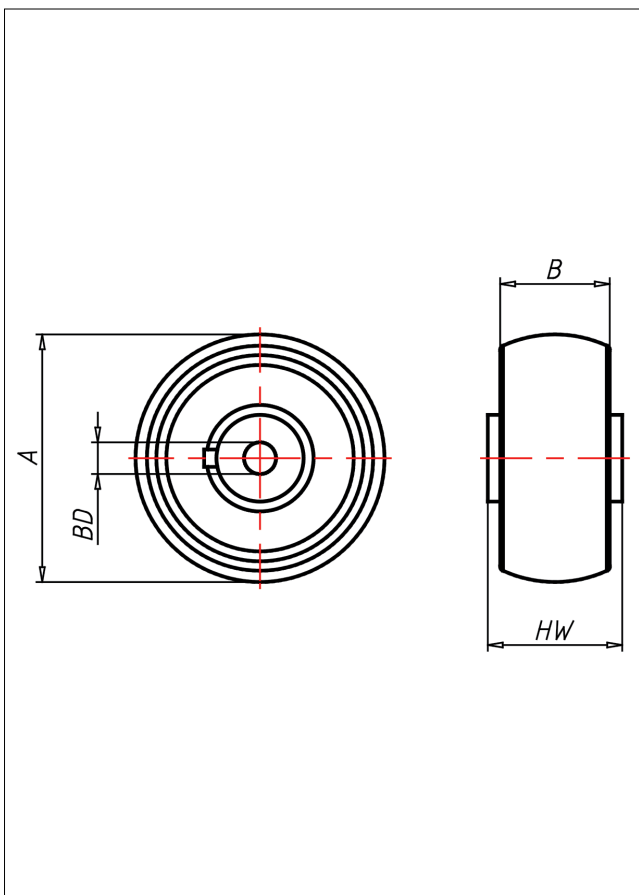

CI/Q Rad

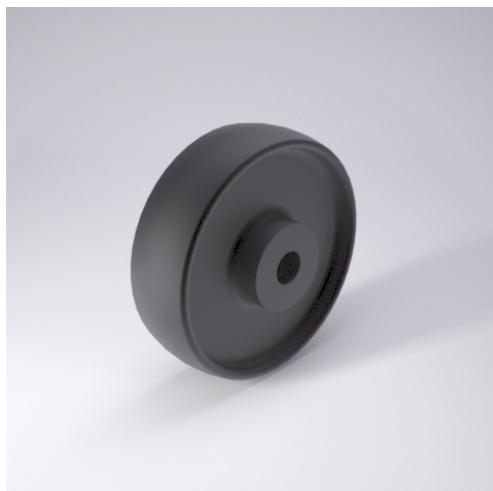

CI/Q



+300 °C***
-40 °C max. 7000 kg

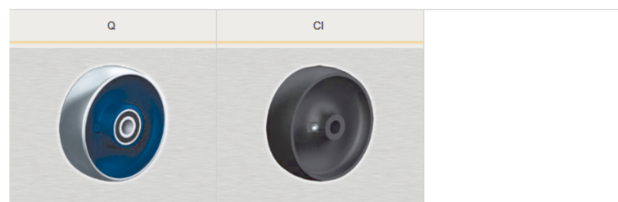

Lackiertes Gusseisenrad, ballig überdrehte Lauffläche

- leichter Lauf auf glatten Böden
- sehr hohe Tragkraft
- sehr abriebfest
- mit Gleit- oder Kugellager für hohe Temperaturen

Technische Details

ORDERNO (Artikel-nummer)	175 QK 20
WDAB (Rad-Ø A x Breite B / mm)	175x48
LC (Tragkraft / kg)	1200
HW (Nabellänge / mm)	48
FL (Einbaulänge / mm)	47
WB (Radlager)	2 Rillen-Kugellager 6205 ZZ
BD (Bohrungsdurchmesser / mm)	20