

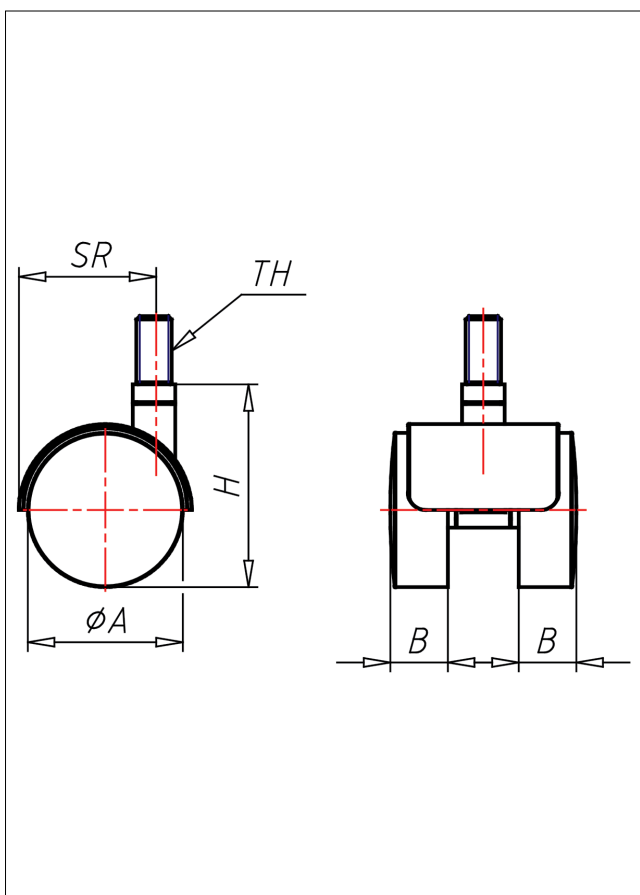

1800 M8/M10 P

Lenkrolle



1800-P



schwarzes Gehäuse aus hochwertigem Kunststoff
Schwenklager mit Gleitlager Rad aus hochwertigem Kunststoff Radachse vernietet

Technische Details

ORDERNO (Artikel-nummer)	1800 M8 30 P
WDAB (Rad- \varnothing A x Breite B / mm)	30x11+11
LC (Tragkraft / kg)	70
H (Bauhöhe H / mm)	37
TH (Gewinde / mm)	M8x15
SR (Schwenkradius / mm)	35
WB (Radlager)	Gleitlager