

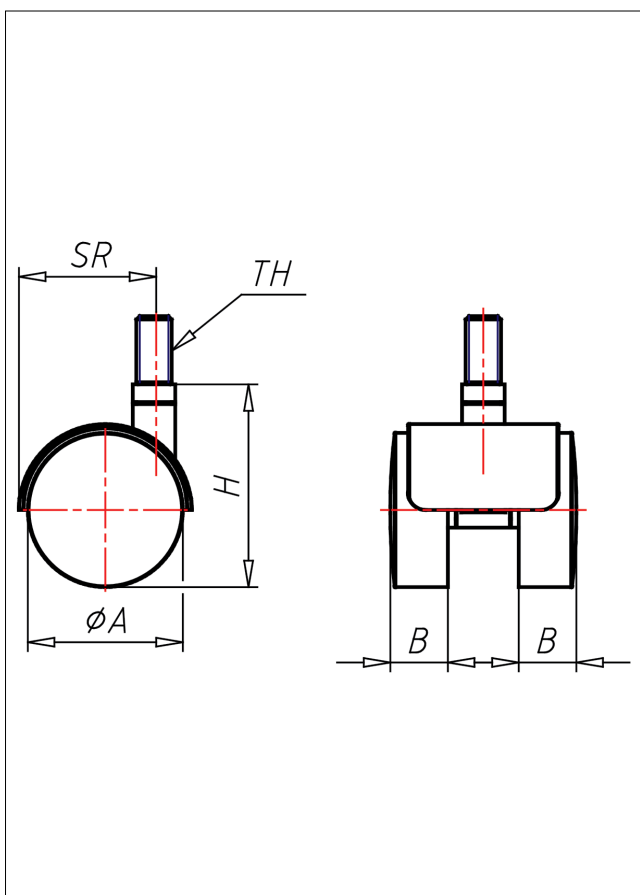

1800 M8/M10 G

Lenkrolle

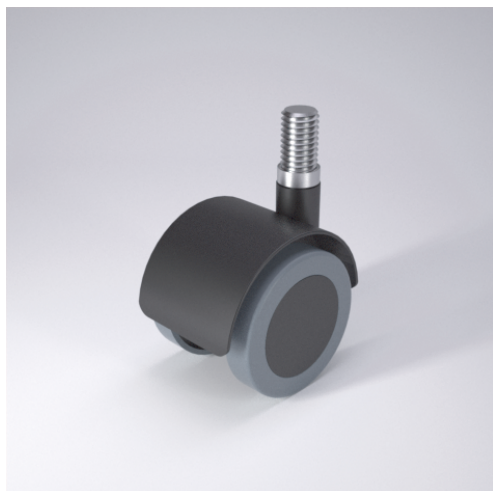

1800-G



+60 °C max.
-20 °C 70 kg



schwarzes Gehäuse aus hochwertigem Kunststoff
Schwenklager mit Gleitlager Felge
aus hochwertigem Kunststoff Rad mit weicher Lauffläche - spurfrei
Radachse vernietet

Technische Details

ORDERNO (Artikel-nummer)	1800 M8 40 G
WDAB (Rad-Ø A x Breite B / mm)	40x8+8
LC (Tragkraft / kg)	30
H (Bauhöhe H / mm)	54
TH (Gewinde / mm)	M8x15
SR (Schwenkradius / mm)	43
WB (Radlager)	Gleitlager