

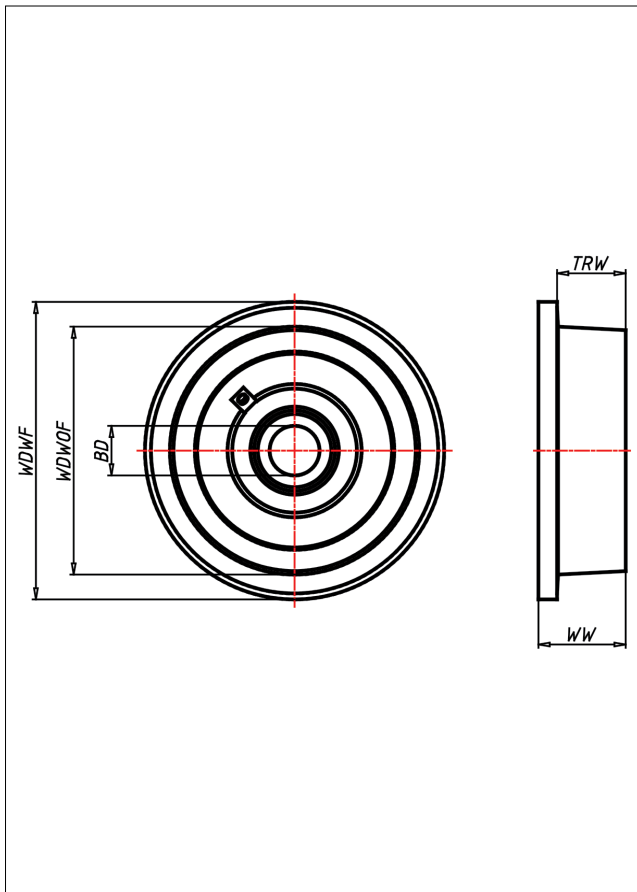

# SSF Spurkranzrad

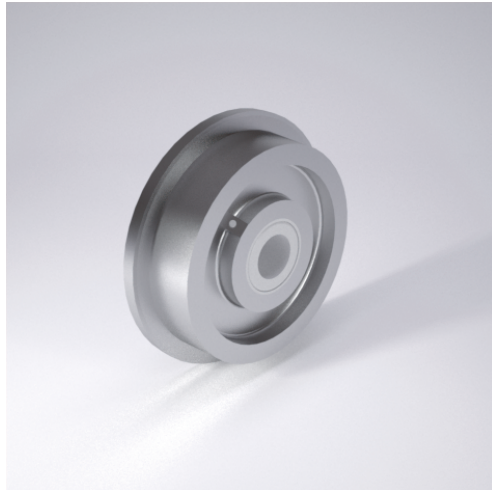

## SSF Spurkranzrad



Spurkranzrad aus Stahl BS 970  
Lauffläche sauber überdreht  
Neigungswinkel 3°

- sehr hohe Tragkraft
- sehr abriebfest
- für hohe Temperaturen

## Technische Details

ORDERNO (Artikel-nummer)	200 SSF-30
WDWOF (Rad-Ø o. Spurkranz / mm)	200
WDFW (Rad-Ø m. Spurkranz / mm)	240
TRW (Laufflächenbreite / mm)	55
WW (Radbreite / mm)	70
LC (Tragkraft / kg)	6100
HW (Nabellänge / mm)	70
WB (Radlager)	Bohrung mit Keilnut
BD (Bohrungsdurchmesser / mm)	30 H7