

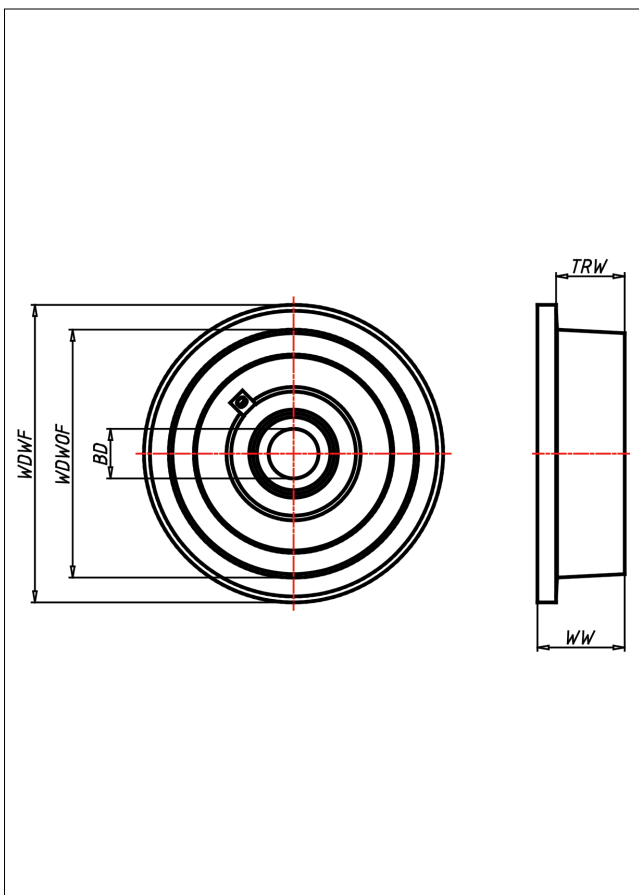

# SSF Spurkranzrad

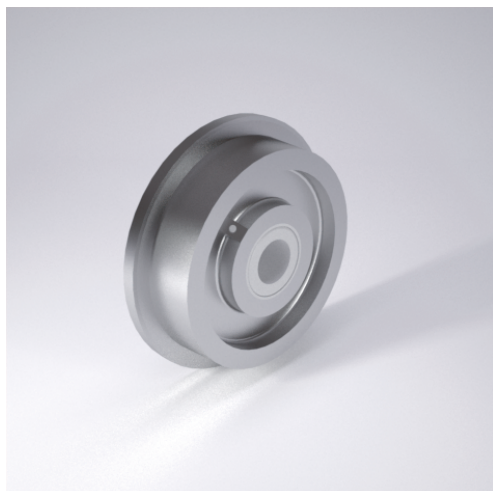

## SSF Spurkranzrad



Spurkranzrad aus Stahl BS 970  
Lauffläche sauber überdreht  
Neigungswinkel 3°

- sehr hohe Tragkraft
- sehr abriebfest
- für hohe Temperaturen

## Technische Details

ORDERNO (Artikel-nummer)	200 SSFK 40
WDWOF (Rad-Ø o. Spurkranz / mm)	200
WDWF (Rad-Ø m. Spurkranz / mm)	240
TRW (Laufflächenbreite / mm)	55
WW (Radbreite / mm)	70
LC (Tragkraft / kg)	3384
HW (Nabellänge / mm)	70
WB (Radlager)	Kugellager
BD (Bohrungsdurchmesser / mm)	40