

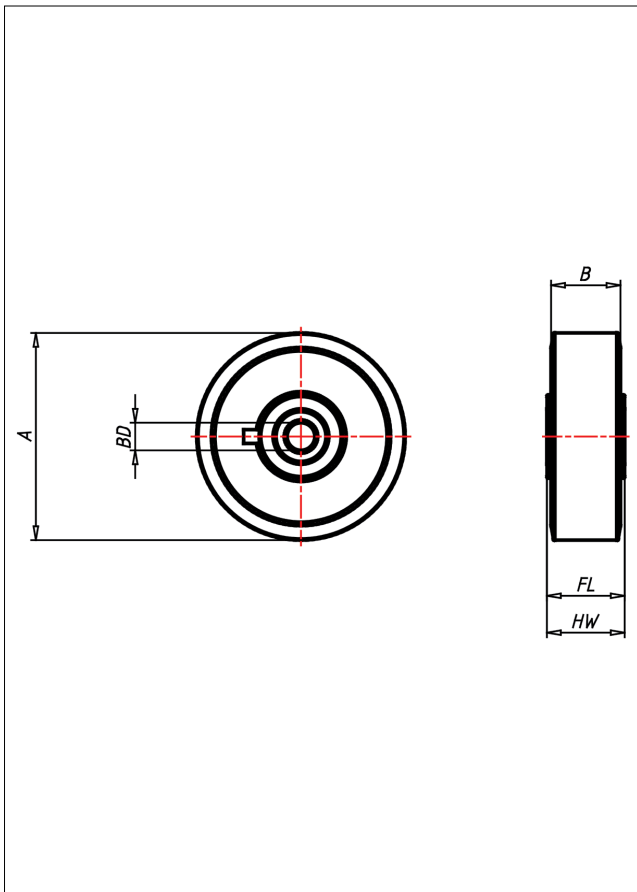

TLS

Rad

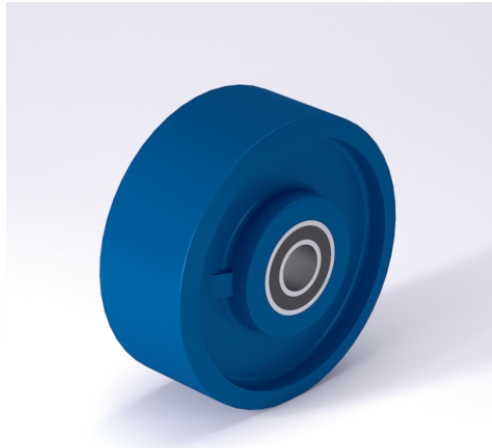

TLS



Radkörper aus Spritzguss-Aluminium-Legierung
Core in die-cast aluminium alloy
Laufbelag aus Guss-Polyurethan 70x3 Shore A
Coated in cast polyurethane, 70x3 Shore A

- sehr leise in motion
- geringer Rollwiderstand
- abrieb- und reißfest
- hohe Stoßfestigkeit
- leichte Reinigung
- sehr beständig gegen viele aggressive Medien
- low rolling resistance
- high abrasion and tear resistance
- high resistance to shocks
- easy to clean
- good chemical resistance

Technische Details

ORDERNO (Artikel-nummer)	200 TLSK 20
WDAB (Rad-Ø A x Breite B / mm)	200x50
LC (Tragkraft / kg)	700
HW (Nabellänge / mm)	56
FL (Einbaulänge / mm)	56
WB (Radlager)	2 Kugellager 6204-2RS
BD (Bohrungsdurchmesser / mm)	20