

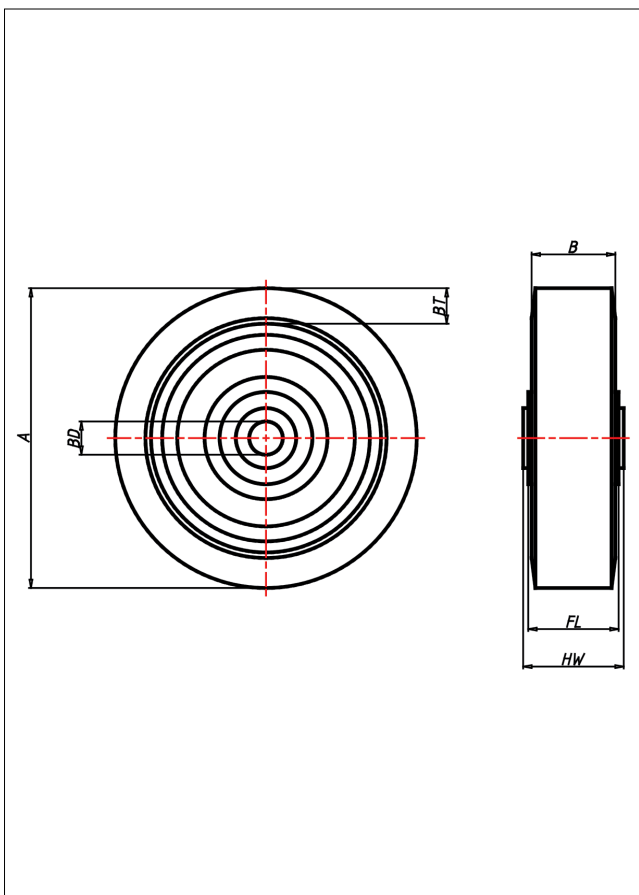

RN Rad

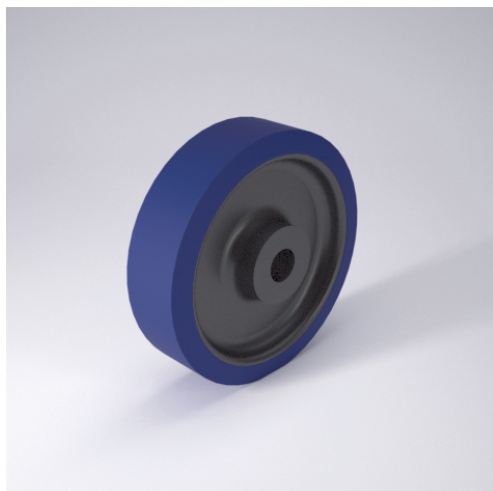

RN



+70 °C
-20 °C max. 480 kg

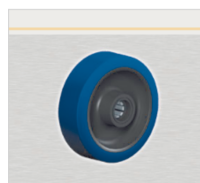

Radkörper aus Polyamid 6 - 1. Wahl, schwarz
Elastik-Vollgummireifen, blau, 73±5 Shore A
aufvulkanisiert

- hoher Fahrkomfort
- sehr laufruhig
- geringer Rollwiderstand
- abriebfest
- korrosionsbeständig
- spurfrei

Technische Details

ORDERNO (Artikel-nummer)	250 RNB 20
WDAB (Rad-Ø A x Breite B / mm)	250x50
LC (Tragkraft / kg)	480
BT (Reifenstärke / mm)	25
HW (Nabenlänge / mm)	60
FL (Einbaulänge / mm)	60
WB (Radlager)	Rollenlager
BD (Bohrungsdurchmesser / mm)	20