

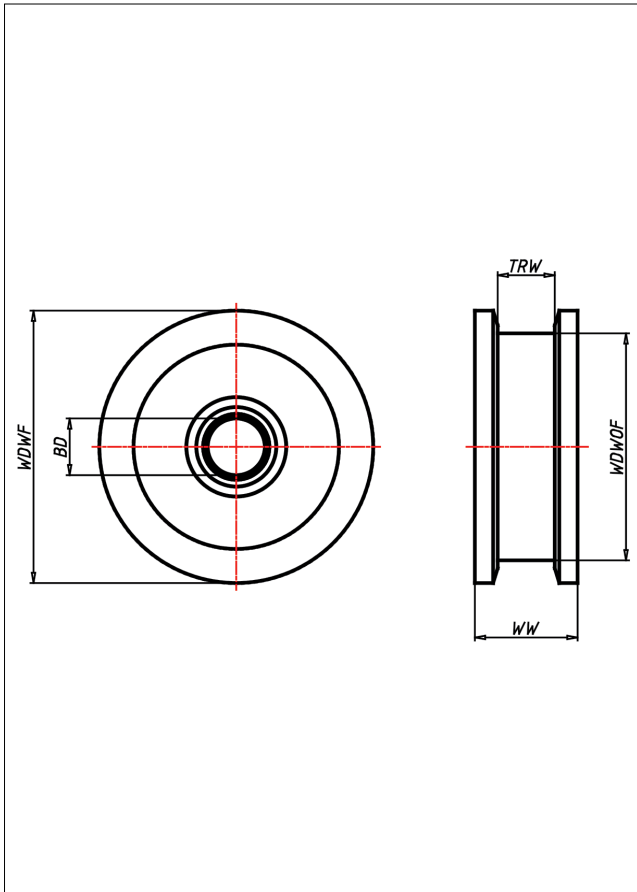

SDF

Doppel-Spurkranzrad



SDF Doppel-Spurkranzrad



Doppel-Spurkranzrad aus Stahl BS 970
Lauffläche sauber überdreht

- sehr hohe Tragkraft
- sehr abriebfest
- für hohe Temperaturen

Technische Details

ORDERNO (Artikel-nummer)	250 SDF-50
WDWOF (Rad-Ø o. Spurkranz / mm)	250
WDWF (Rad-Ø m. Spurkranz / mm)	295
TRW (Laufflächenbreite / mm)	60
WW (Radbreite / mm)	100
LC (Tragkraft / kg)	8300
HW (Nabellänge / mm)	100
WB (Radlager)	Bohrung mit Keilnut
BD (Bohrungsdurchmesser / mm)	50 H7