

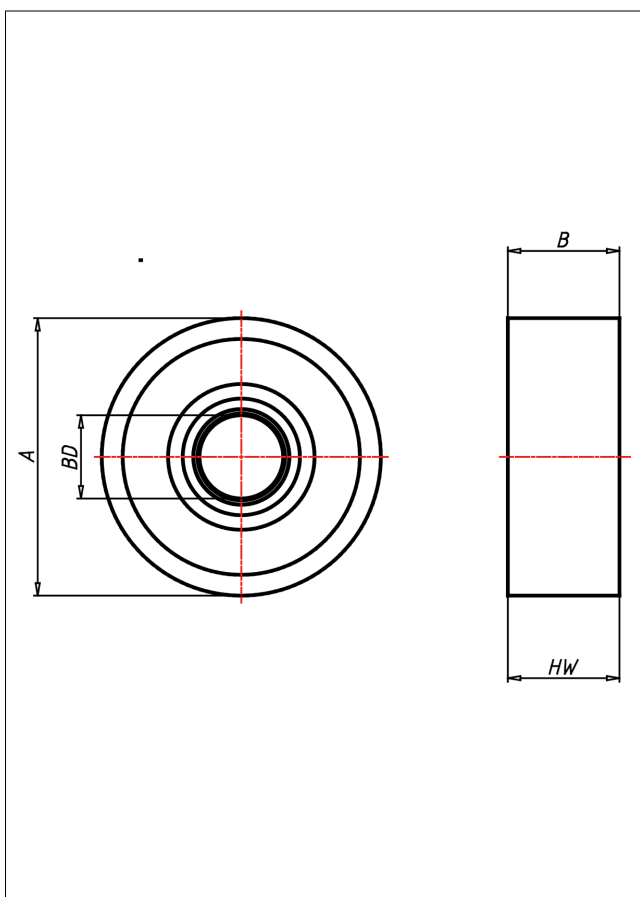

SFT Schienenrad



SFT Schienenrad



+350 °C
-30 °C max.
50400 kg

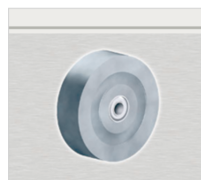

Schienenrad aus Stahl BS 970
Lauffläche sauber überdreht

- sehr hohe Tragkraft
- sehr abriebfest
- für hohe Temperaturen

Technische Details

ORDERNO (Artikel-nummer)	250 SFT-50
WDAB (Rad-Ø A x Breite B / mm)	250x100
LC (Tragkraft / kg)	13900
HW (Nabellänge / mm)	100
WB (Radlager)	Bohrung mit Keilnut
BD (Bohrungsdurchmesser / mm)	50 H7