

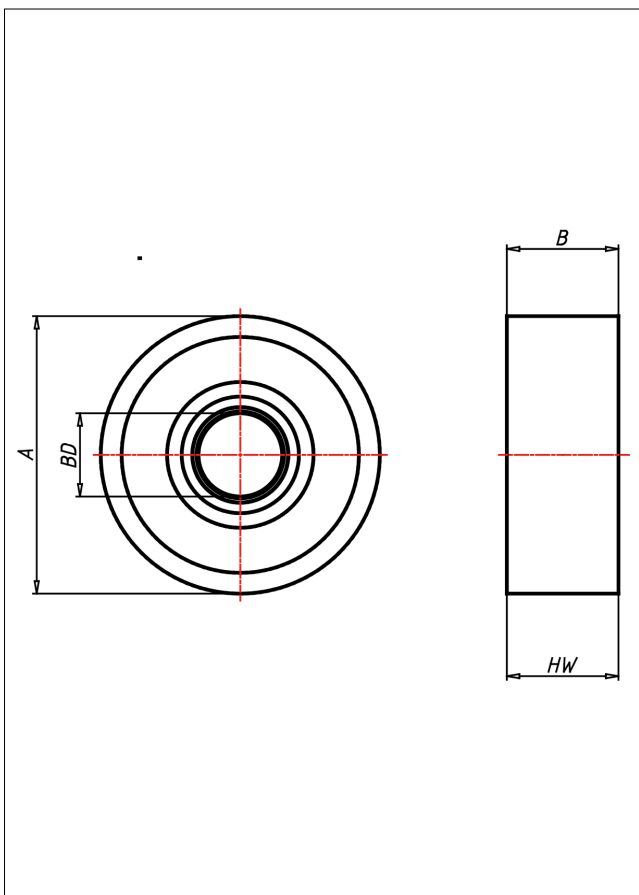

SFT Schienenrad

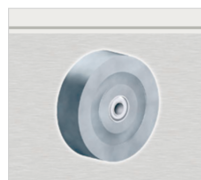

SFT Schienenrad



Schienenrad aus Stahl BS 970
Lauffläche sauber überdreht

- sehr hohe Tragkraft
- sehr abriebfest
- für hohe Temperaturen

Technische Details

ORDERNO (Artikel-nummer)	300 SFT-50
WDAB (Rad-Ø A x Breite B / mm)	300x100
LC (Tragkraft / kg)	16800
HW (Nabellänge / mm)	100
WB (Radlager)	Bohrung mit Keilnut
BD (Bohrungsdurchmesser / mm)	50 H7