

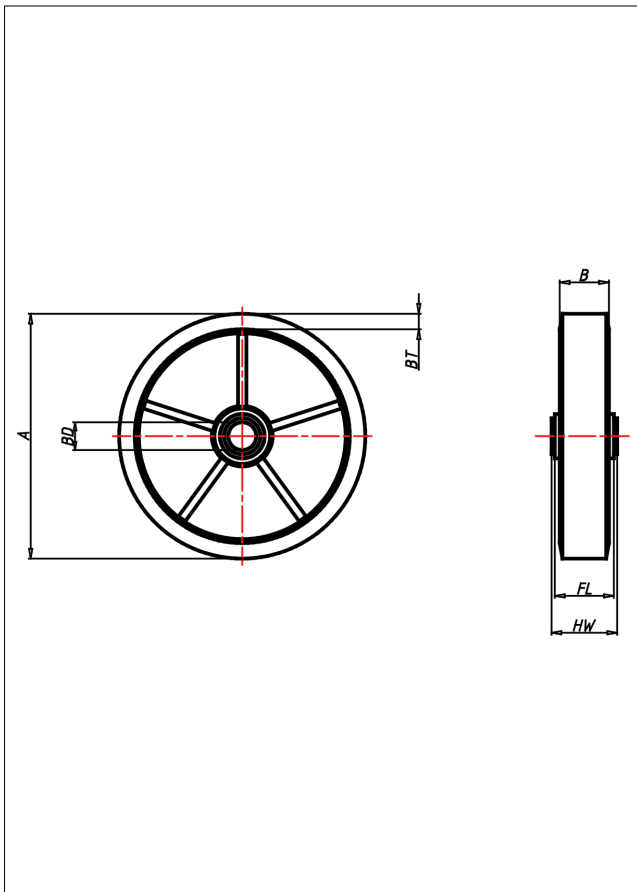

Z/SU Rad



Z/SU



Z

Radkörper aus Gusseisen lackiert
Laufbelag aus Guss-Polyurethan 95:3 Shore A

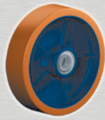

- geräuscharmer Lauf
- geringer Rollwiderstand
- abrieb- und reißfest
- hohe Stoßfestigkeit
- sehr beständig gegen viele aggressive Medien

Technische Details

ORDERNO (Artikel-nummer)	300 ZK 30
WDAB (Rad-Ø A x Breite B / mm)	300x70
LC (Tragkraft / kg)	2200
BT (Reifenstärke / mm)	13.5
HW (Nabellänge / mm)	72.5
FL (Einbaulänge / mm)	72
WB (Radlager)	2 Rillen-Kugellager 6306 ZZ
BD (Bohrungsdurchmesser / mm)	30