

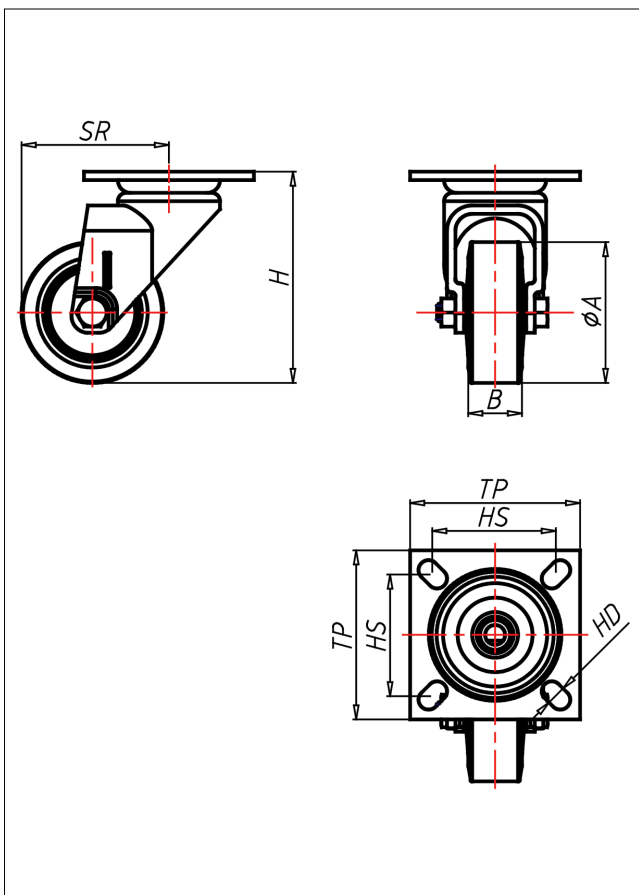

310X PT-G

Lenkrolle



310XP-G



+60 °C max. 50 kg
-20 °C

LENKROLLE	LENKROLLE MIT TOTALFESTSTELLER																			
																				
<ul style="list-style-type: none"> • spurfrei • geräuscharmer Lauf • großer Fahrkomfort • beständig gegen verdünnte Säuren Thermoplastisches Elastomer Felge Polyamid 6 → Seite 268	 zweifaches Kugellager - verschraubt, Radachse verschraubt - gesichert, alle Teile aus Edelstahl rostfrei → Seite	AUSWAHLHILFE: <table border="0"> <tr> <td>○</td><td>+</td><td>++</td> </tr> <tr> <td>○</td><td>x</td><td>x</td> </tr> <tr> <td>○</td><td>x</td><td>x</td> </tr> <tr> <td>○</td><td>x</td><td>x</td> </tr> <tr> <td>○</td><td>x</td><td>x</td> </tr> <tr> <td>○</td><td>x</td><td>x</td> </tr> </table>	○	+	++	○	x	x	○	x	x	○	x	x	○	x	x	○	x	x
○	+	++																		
○	x	x																		
○	x	x																		
○	x	x																		
○	x	x																		
○	x	x																		

Technische Details

ORDERNO (Artikel-nummer)	310X PT 50 G
WDAB (Rad-Ø A x Breite B / mm)	50x19
LC (Tragkraft / kg)	40
H (Bauhöhe H / mm)	75
TP (Plattengröße / mm)	60x60
HS (Lochabstand / mm)	40x40/46x46
HD (Loch-Ø / mm)	7
SR (Schwenkradius / mm)	52
WB (Radlager)	Polyamid-Gleitlager