

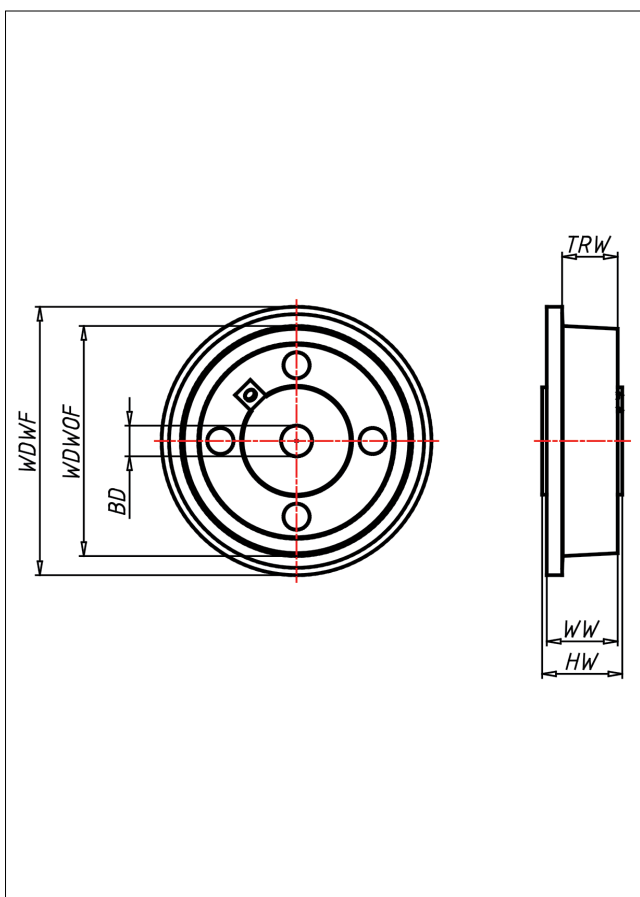

SPA

Spurkranzrad



SPA Spurkranzrad

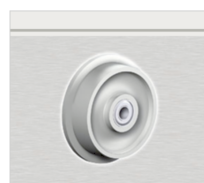

Spurkranzrad aus hochwertigem Polyamid 6
Lauffläche sauber überdreht,
Lauffläche 3° ansteigend

- geringer Rollwiderstand
- hohe Abriebfestigkeit

Technische Details

ORDERNO (Artikel-nummer)	40 SPA-15
WDWOF (Rad-Ø o. Spurkranz / mm)	40
WDWF (Rad-Ø m. Spurkranz / mm)	55
TRW (Laufflächenbreite / mm)	12
WW (Radbreite / mm)	18
LC (Tragkraft / kg)	40
HW (Nabellänge / mm)	18
WB (Radlager)	Gleitlager
BD (Bohrungsdurchmesser / mm)	15