

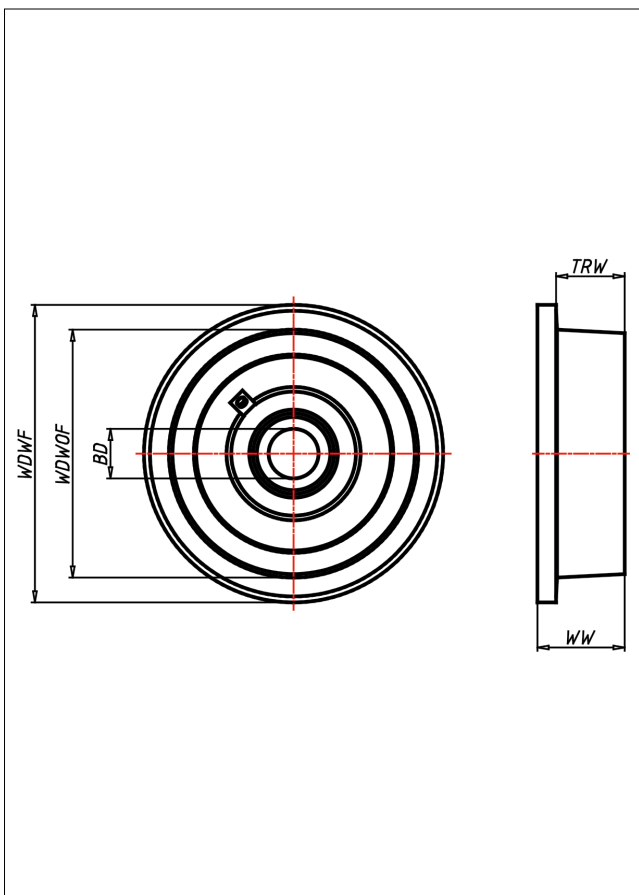

SSF Spurkranzrad

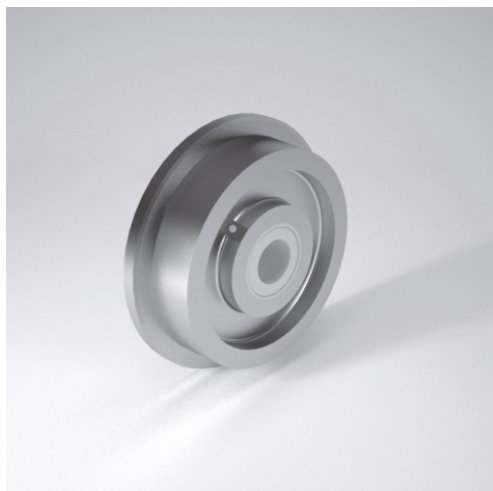

SSF Spurkranzrad



Spurkranzrad aus Stahl BS 970
Lauffläche sauber überdreht
Neigungswinkel 3°

- sehr hohe Tragkraft
- sehr abriebfest
- für hohe Temperaturen

Technische Details

ORDERNO (Artikel-nummer)	400 SSFTM 75
WDWOF (Rad-Ø o. Spurkranz / mm)	400
WDWF (Rad-Ø m. Spurkranz / mm)	450
TRW (Laufflächenbreite / mm)	70
WW (Radbreite / mm)	100
LC (Tragkraft / kg)	15600
HW (Nabellänge / mm)	100
WB (Radlager)	Schräggrollenlager
BD (Bohrungsdurchmesser / mm)	75