

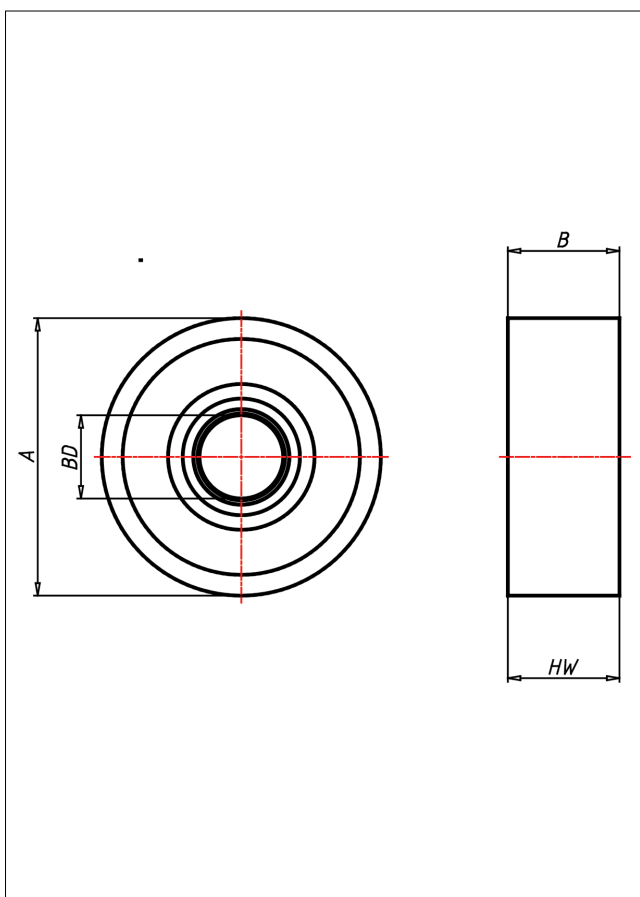

SFT Schienenrad



SFT Schienenrad



+350 °C
-30 °C max.
50400 kg

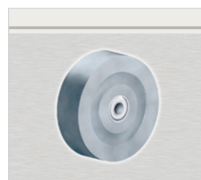

Schienenrad aus Stahl BS 970
Lauffläche sauber überdreht

- sehr hohe Tragkraft
- sehr abriebfest
- für hohe Temperaturen

Technische Details

ORDERNO (Artikel-nummer)	450 SFT-75
WDAB (Rad-Ø A x Breite B / mm)	450x125
LC (Tragkraft / kg)	31500
HW (Nabellänge / mm)	125
WB (Radlager)	Bohrung mit Keilnut
BD (Bohrungsdurchmesser / mm)	75 H7