

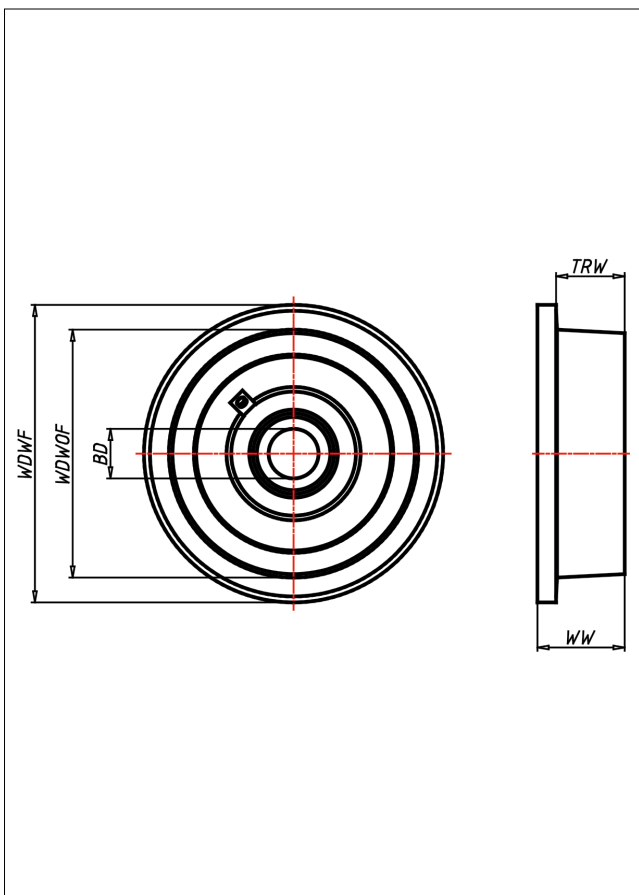

SSF Spurkranzrad

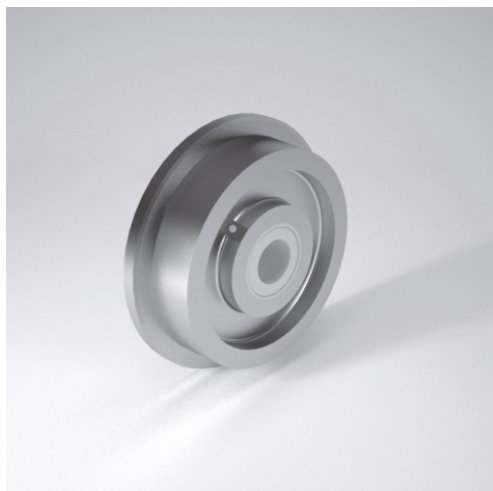

SSF Spurkranzrad



Spurkranzrad aus Stahl BS 970
Lauffläche sauber überdreht
Neigungswinkel 3°

- sehr hohe Tragkraft
- sehr abriebfest
- für hohe Temperaturen

Technische Details

ORDERNO (Artikel-nummer)	450 SSF-75
WDWOF (Rad-Ø o. Spurkranz / mm)	450
WDFW (Rad-Ø m. Spurkranz / mm)	495
TRW (Laufflächenbreite / mm)	95
WW (Radbreite / mm)	125
LC (Tragkraft / kg)	24000
HW (Nabellänge / mm)	125
WB (Radlager)	Bohrung mit Keilnut
BD (Bohrungsdurchmesser / mm)	75 H7