

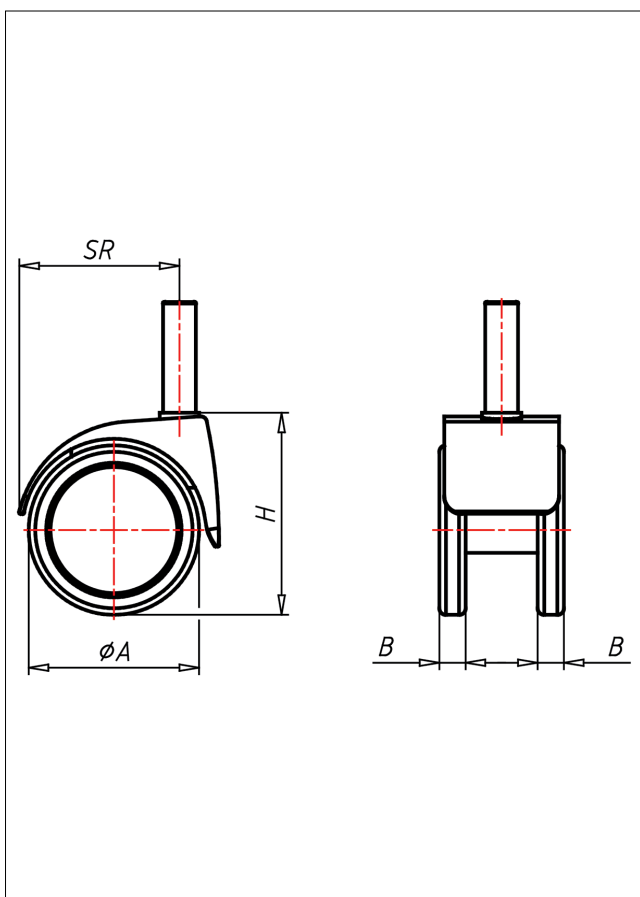

# 530 P

## Lenkrolle



530-P



+60 °C max.  
-20 °C 60 kg



schwarzes Gehäuse aus Polyamid 6  
Schwenklager mit kombiniertem  
Gleit-Kugellager  
schwarzes Polyamid Vollrad  
Radfeststeller glasfaserverstärkt  
Radachse vernietet

### Technische Details

ORDERNO (Artikel-nummer)	530 11x30 75 P
WDAB (Rad-Ø A x Breite B / mm)	75x13+13
LC (Tragkraft / kg)	60
H (Bauhöhe H / mm)	93
BOLT (Stift / mm)	11x30
SR (Schwenkradius / mm)	63.5
WB (Radlager)	Polyamid-Gleitlager