

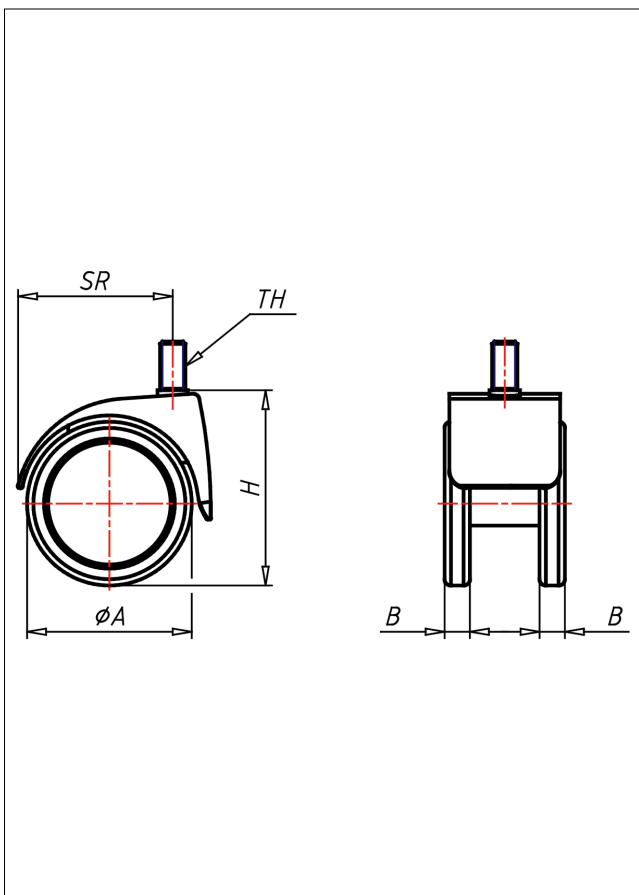

530 M8/M10/M12 PU

Lenkrolle

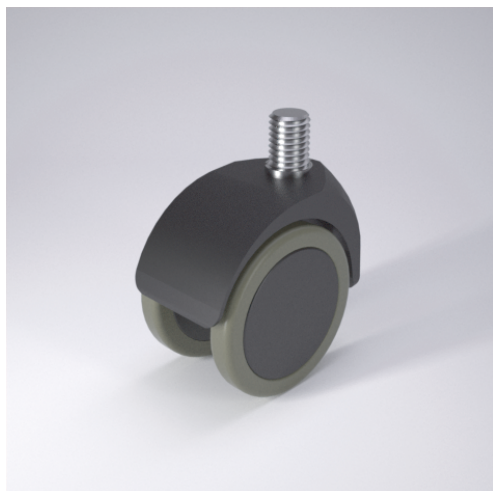

530-PU



schwarzes Gehäuse aus Polyamid 6
Schwenklager mit kombiniertem
Gleit-Kugellager
Felge Polyamid schwarz
elastischer PUR-Reifen - spurfrei
Radfeststeller glasfaserverstärkt
Radachse vernietet

Technische Details

ORDERNO (Artikel-nummer)	530 M8 50 PU
WDAB (Rad-Ø A x Breite B / mm)	52x8+8
LC (Tragkraft / kg)	40
H (Bauhöhe H / mm)	62
TH (Gewinde / mm)	M8x15
SR (Schwenkradius / mm)	46
WB (Radlager)	Polyamid-Gleitlager