

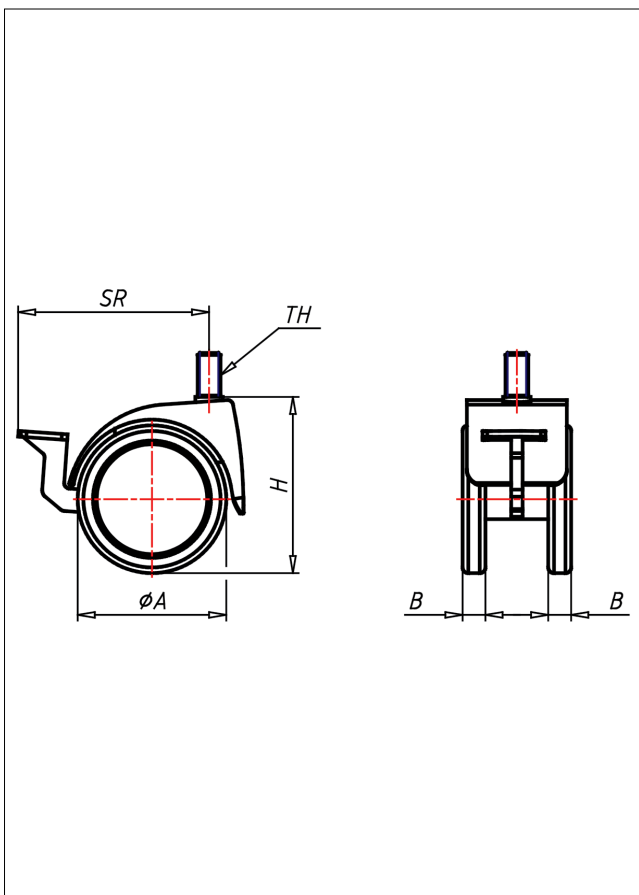

531 M8/M10/M12 PEL

Lenkrolle mit Radfeststeller



530-PEL



+60 °C
-20 °C
max.
60 kg



schwarzes Gehäuse aus Polyamid 6
Schwenklager mit kombiniertem
Gleit-Kugellager
schwarzes Polyamid Vollrad
elektrisch leitfähig
Radfeststeller glasfaserverstärkt
Radachse vernietet

Technische Details

ORDERNO (Artikel-nummer)	531 M10 50 PEL
WDAB (Rad-Ø A x Breite B / mm)	52x8+8
LC (Tragkraft / kg)	40
H (Bauhöhe H / mm)	62
TH (Gewinde / mm)	M10x15
SR (Schwenkradius / mm)	69
WB (Radlager)	Polyamid-Gleitlager