

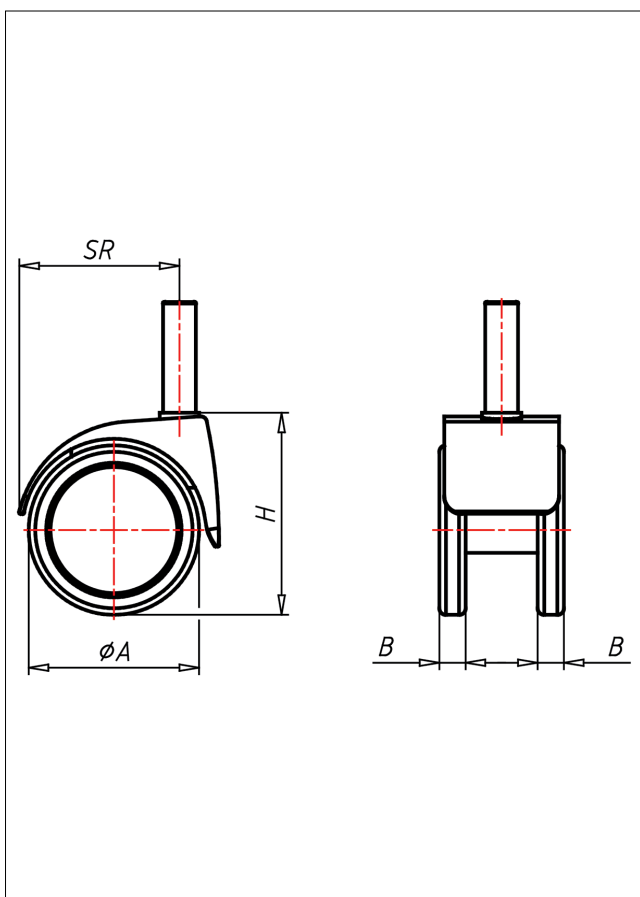

532 PU Stuhlrollen

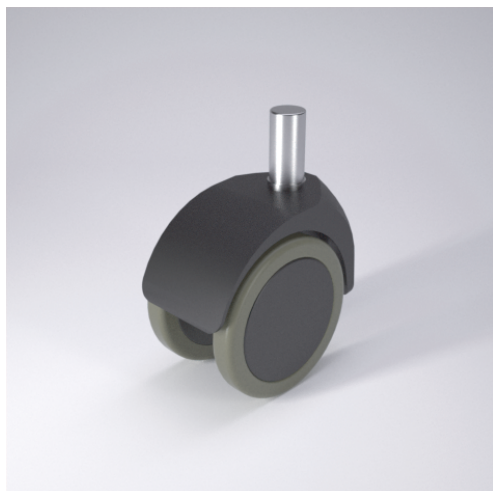

Stuhlrollen-PU Stuhlrollen



BÜROSTUHLROLLE mit lastabhängiger Radbremse nach EN 12529
Schwenklager mit kombiniertem Gleit-Kugellager
Felge Polyamid schwarz
elastischer PUR-Reifen - spurfrei
Radachse vernietet

Technische Details

ORDERNO (Artikel-nummer)	532 11x22 50 PU
WDAB (Rad-Ø A x Breite B / mm)	52x8+8
LC (Tragkraft / kg)	40
H (Bauhöhe H / mm)	62
BOLT (Stift / mm)	11x22
SR (Schwenkradius / mm)	46
WB (Radlager)	Polyamid-Gleitlager