

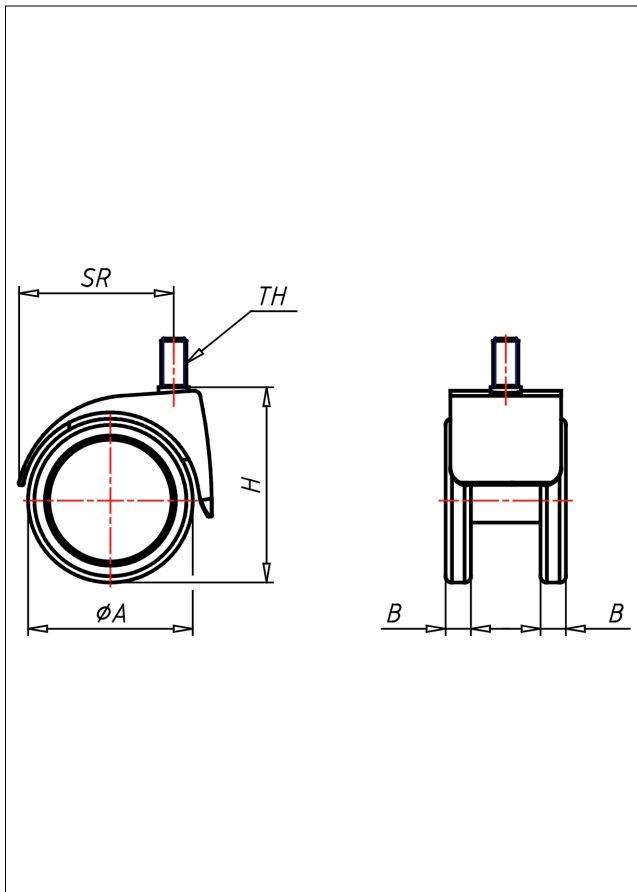

540 M8/M10/M12 PU

Lenkrolle

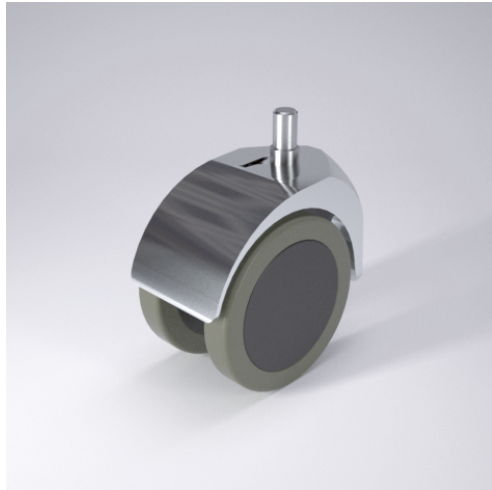

Technische Details

ORDERNO (Artikel-nummer)	540 M10 100 PU
WDAB (Rad-Ø A x Breite B / mm)	100x13+13
LC (Tragkraft / kg)	70
H (Bauhöhe H / mm)	124
TH (Gewinde / mm)	M10x15
SR (Schwenkradius / mm)	85
WB (Radlager)	Polyamid-Gleitlager