

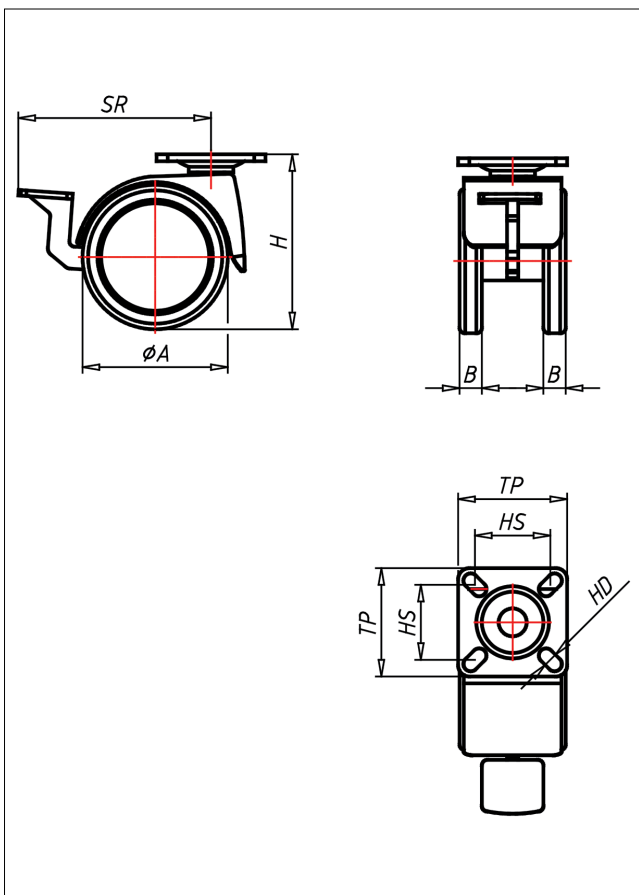

541 PT PU

Lenkrolle mit Radfeststeller

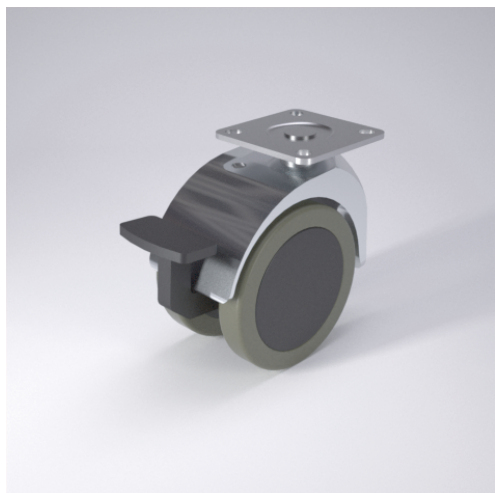

Technische Details

ORDERNO (Artikel-nummer)	541 PT 75 PU
WDAB (Rad-Ø A x Breite B / mm)	75x13+13
LC (Tragkraft / kg)	60
H (Bauhöhe H / mm)	96
TP (Plattengröße / mm)	55x55
HS (Lochabstand / mm)	42x42/40x40
HD (Loch-Ø / mm)	6.2
SR (Schwenkradius / mm)	88
WB (Radlager)	Polyamid-Gleitlager