

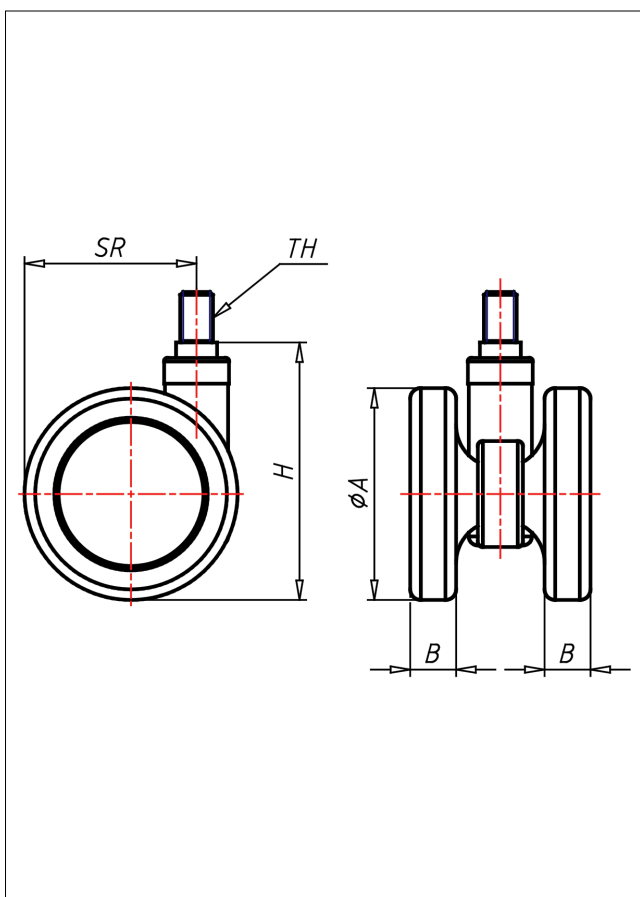

550 M10/M12 PUEL

Lenkrolle



Technische Details

ORDERNO (Artikel-nummer)	550 M10 65 PUEL
WDAB (Rad- ϕ A x Breite B / mm)	65x14+14
LC (Tragkraft / kg)	70
H (Bauhöhe H / mm)	79
TH (Gewinde / mm)	M10x15
SR (Schwenkradius / mm)	52.5
WB (Radlager)	Polyamid-Gleitlager