

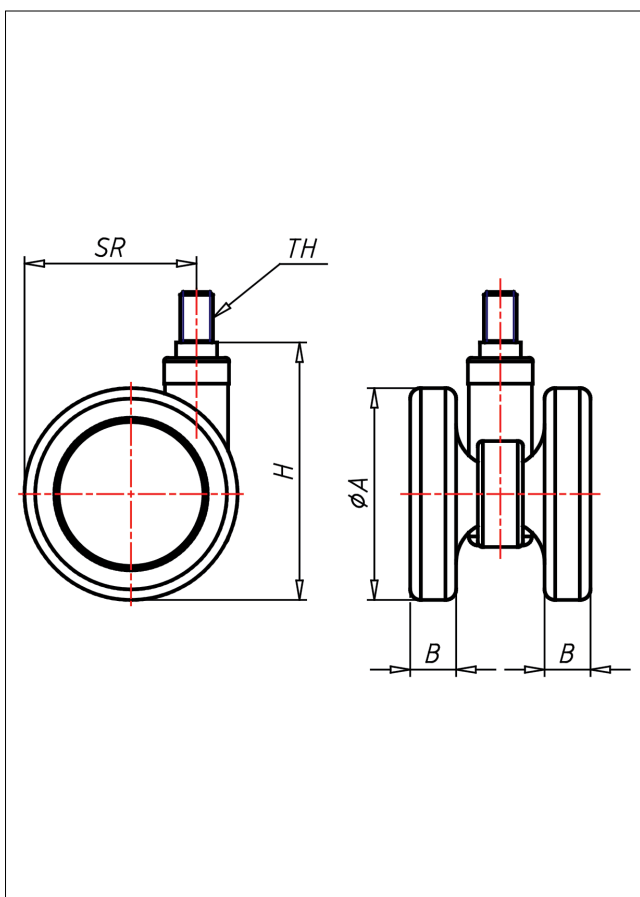

550 M10/M12 PU

Lenkrolle

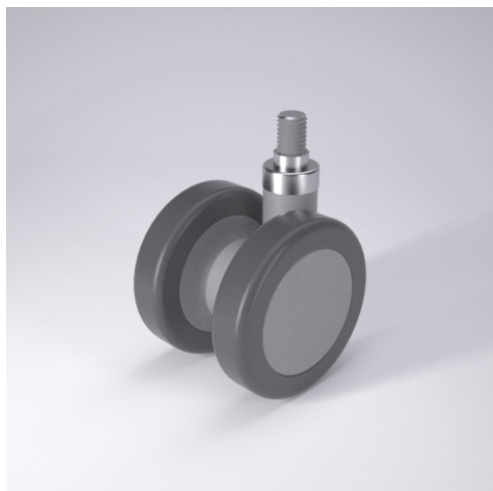

Technische Details

ORDERNO (Artikel-nummer)	550 M12 100 PU
WDAB (Rad-ϕ A x Breite B / mm)	100x20+20
LC (Tragkraft / kg)	100
H (Bauhöhe H / mm)	119
TH (Gewinde / mm)	M12x15
SR (Schwenkradius / mm)	81
WB (Radlager)	Polyamid-Gleitlager