

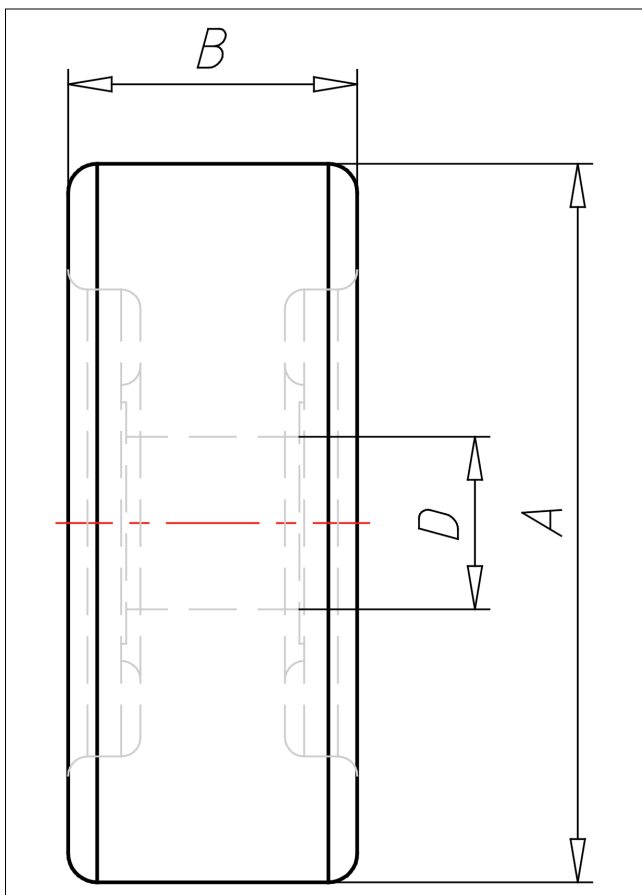

WUDPK

Guide Rollers

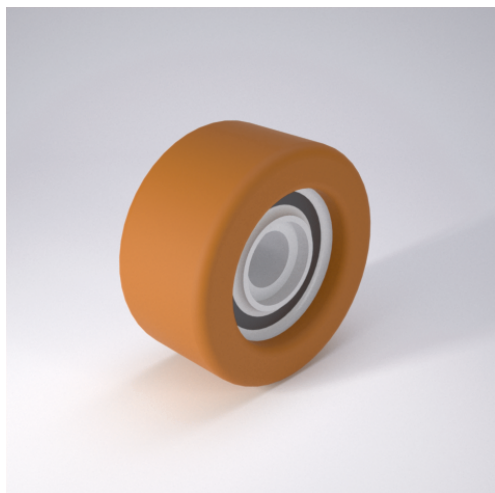

WUDPK Führungsröllchen



+80 °C
-20 °C

max.
260 kg



Präzisionskugellager mit Vulkopan 59 Shore D umspritzt

- lange Lebensdauer
- sehr niedrige Abriebswerte
- geräuscharmer Lauf
- geringer Rollwiderstand
- sehr beständig gegen viele aggressive Medien

Technische Details

ORDERNO (Artikel-nummer)	60x20 WUDPK 17
WDAB (Rad-Ø A x Breite B)	60x20
LC (Tragkraft / kg)	150
TYPE (Type)	X
FL (Einbaulänge / mm)	12
WB (Radlager)	1 Rillen-Kugellager 6203 ZZ
BD (Bohrungsdurchmesser / mm)	17