

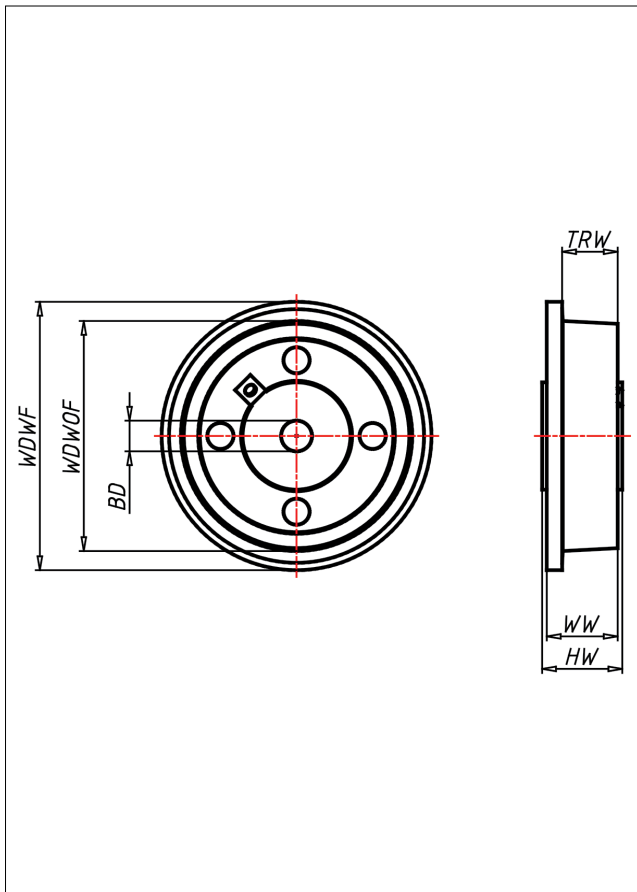

# SPA

## Spurkranzrad



### SPA Spurkranzrad



Spurkranzrad aus hochwertigem Polyamid 6  
Lauffläche sauber überdreht,  
Lauffläche 3° ansteigend

- geringer Rollwiderstand
- hohe Abriebfestigkeit

### Technische Details

ORDERNO (Artikel-nummer)	62 SPA-16
WDWOF (Rad-Ø o. Spurkranz / mm)	62
WDWF (Rad-Ø m. Spurkranz / mm)	75
TRW (Laufflächenbreite / mm)	18
WW (Radbreite / mm)	26
LC (Tragkraft / kg)	100
HW (Nabellänge / mm)	30
WB (Radlager)	Gleitlager
BD (Bohrungsdurchmesser / mm)	16