

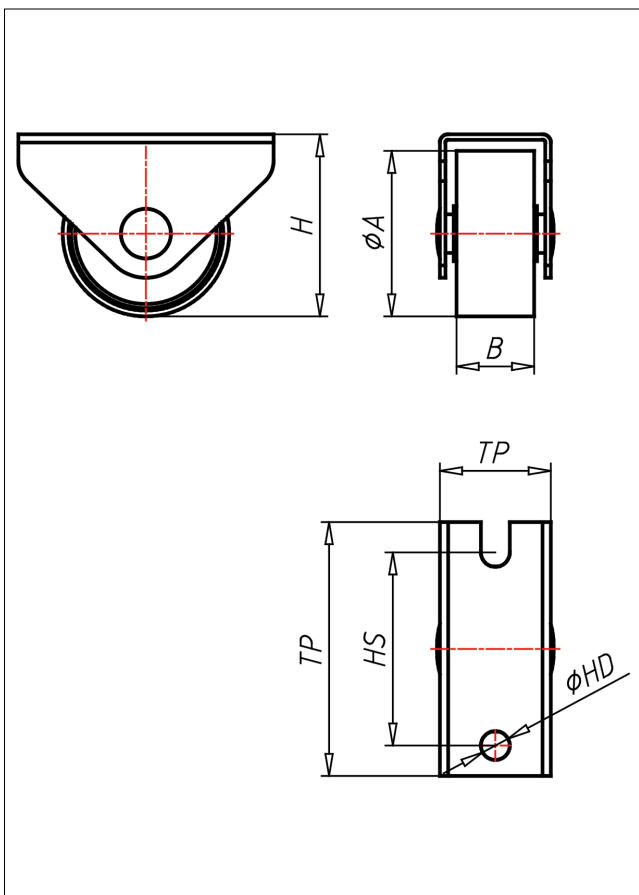

635-P

Bockrolle

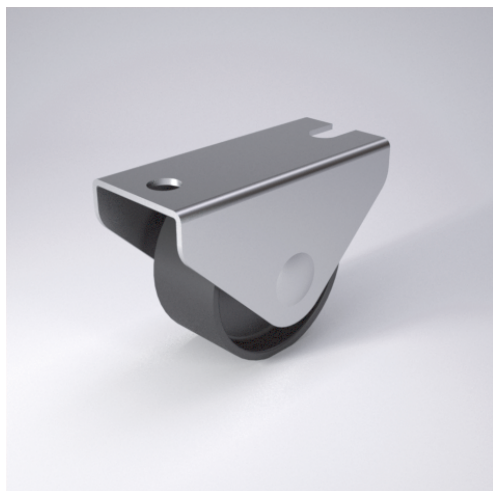

635-P



+60 °C
-20 °C
kg max. 60 kg



Gehäuse aus Stahlblech - nach der Formgebung verzinkt
Rad aus Polyamid 6 schwarz
Radachse vernietet - verzinkt

Technische Details

ORDERNO (Artikel-nummer)	635 16 P
WDAB (Rad-Ø A x Breite B / mm)	16x16
LC (Tragkraft / kg)	30
H (Bauhöhe H / mm)	20
TP (Plattengröße / mm)	43x22
HS (Lochabstand / mm)	32
HD (Loch-Ø / mm)	5.2
WB (Radlager)	Polyamid-Gleitlager