

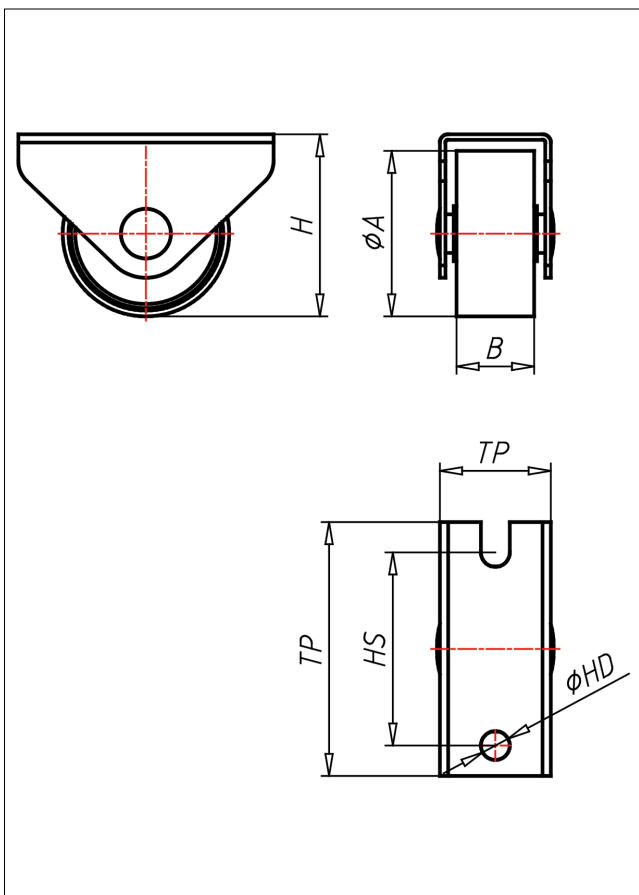

635-P

Bockrolle

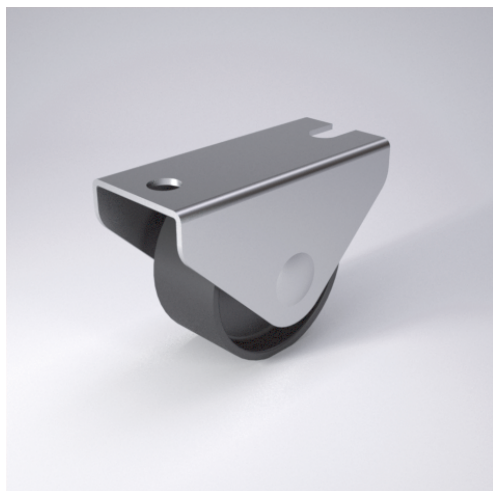

635-P



+60 °C
-20 °C
kg max. 60 kg



Gehäuse aus Stahlblech - nach der
Formgebung verzinkt
Rad aus Polyamid 6 schwarz
Radachse vernietet - verzinkt

Technische Details

ORDERNO (Artikel-nummer)	635 30 P
WDAB (Rad-Ø A x Breite B / mm)	30x14
LC (Tragkraft / kg)	40
H (Bauhöhe H / mm)	33
TP (Plattengröße / mm)	46x20
HS (Lochabstand / mm)	35
HD (Loch-Ø / mm)	5.2
WB (Radlager)	Polyamid-Gleitlager