

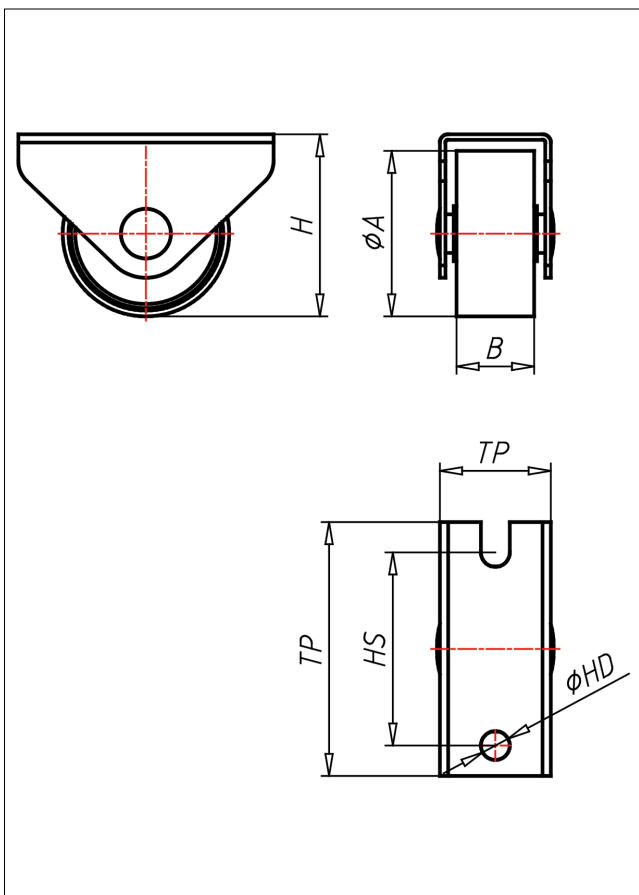

# 635-P

## Bockrolle

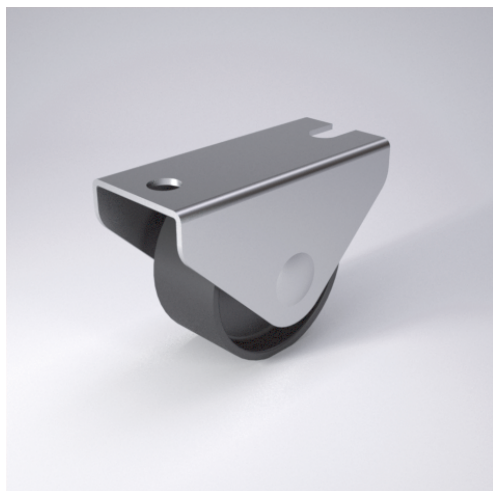

635-P



+60 °C  
-20 °C  
max. 60 kg



Gehäuse aus Stahlblech - nach der Formgebung verzinkt  
Rad aus Polyamid 6 schwarz  
Radachse vernietet - verzinkt

### Technische Details

ORDERNO (Artikel-nummer)	635 50 P
WDAB (Rad-Ø A x Breite B / mm)	50x19
LC (Tragkraft / kg)	60
H (Bauhöhe H / mm)	51
TP (Plattengröße / mm)	68x25
HS (Lochabstand / mm)	54
HD (Loch-Ø / mm)	6.2
WB (Radlager)	Polyamid-Gleitlager