

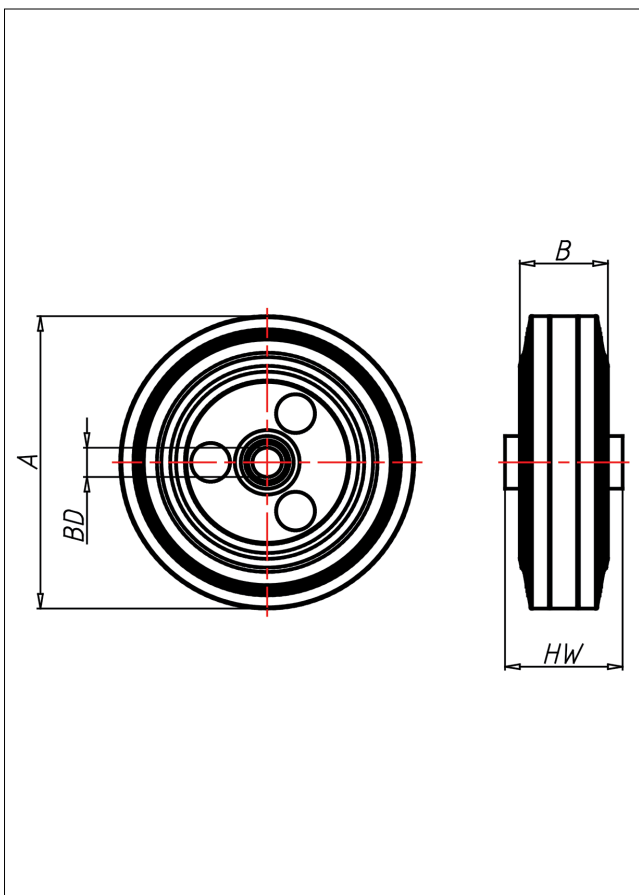

**EL**  
Rad

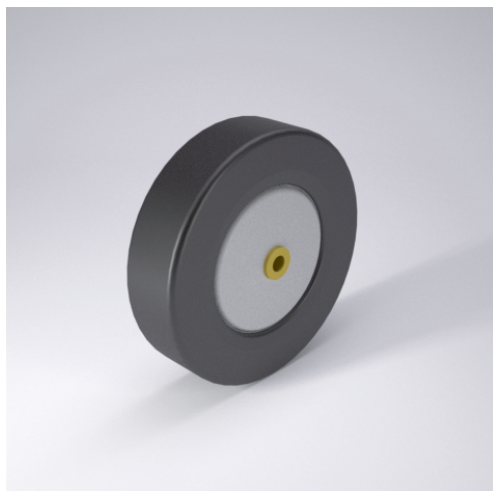

EL +60 °C -20 °C max. 205 kg

	EL**	EL***
Verschraubte Stahlblechfelge verzinkt, Polyamid 6 oder Edelstahl, Vollgummireifen, elektrisch leitfähig, Durchgangswiderstand <math><10^4\Omega</math>		
<ul style="list-style-type: none"><li>• elektrisch leitfähig</li><li>• geräuscharmer Lauf</li><li>• großer Fahrkomfort</li><li>• beständig gegen verdünnte Säuren</li></ul>		

### Technische Details

<b>ORDERNO (Artikel-nummer)</b>	75 ELK 6
<b>WDAB (Rad-Ø A x Breite B / mm)</b>	75x25
<b>LC (Tragkraft / kg)</b>	60
<b>HW (Nabenlänge / mm)</b>	29
<b>FL (Einbaulänge / mm)</b>	29
<b>WB (Radlager)</b>	Kegellager
<b>BD (Bohrungsdurchmesser / mm)</b>	6