

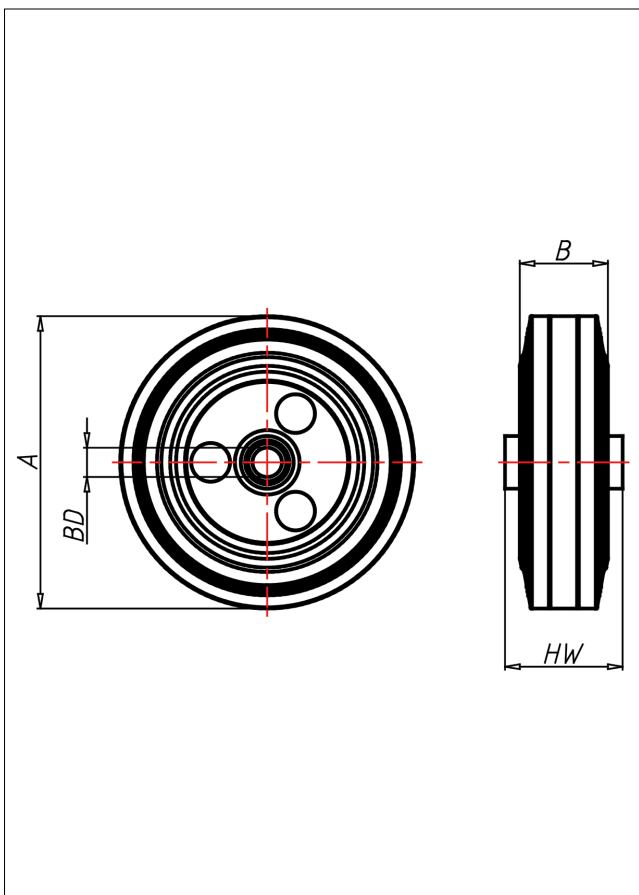

EL
Rad

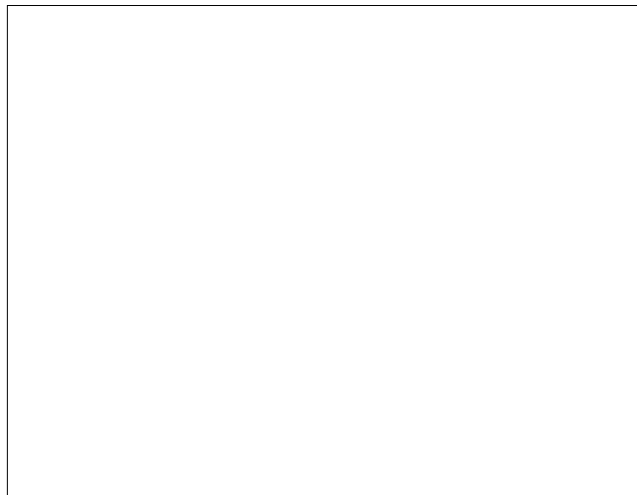
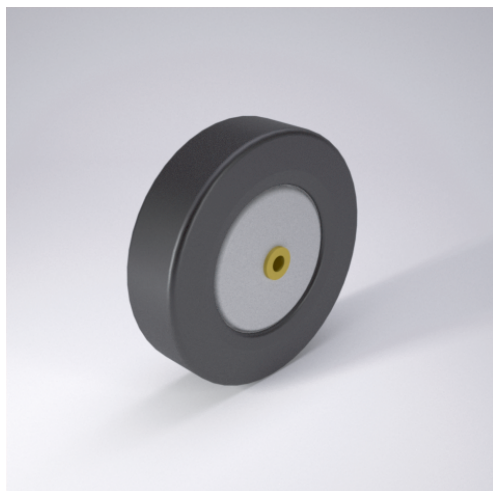

EL

	EL**	EL***
Verschraubte Stahlblechfelge verzinkt, Polyamid 6 oder Edelstahl, Vollgummireifen, elektrisch leitfähig, Durchgangswiderstand <math><10^4\Omega</math>		
<ul style="list-style-type: none">• elektrisch leitfähig• geräuscharmer Lauf• großer Fahrkomfort• beständig gegen verdünnte Säuren		

Technische Details

ORDERNO (Artikel-nummer)	75 ELK 8
WDAB (Rad-Ø A x Breite B / mm)	75x25
LC (Tragkraft / kg)	60
HW (Nabenlänge / mm)	29
FL (Einbaulänge / mm)	29
WB (Radlager)	Kegellager
BD (Bohrungsdurchmesser / mm)	8