

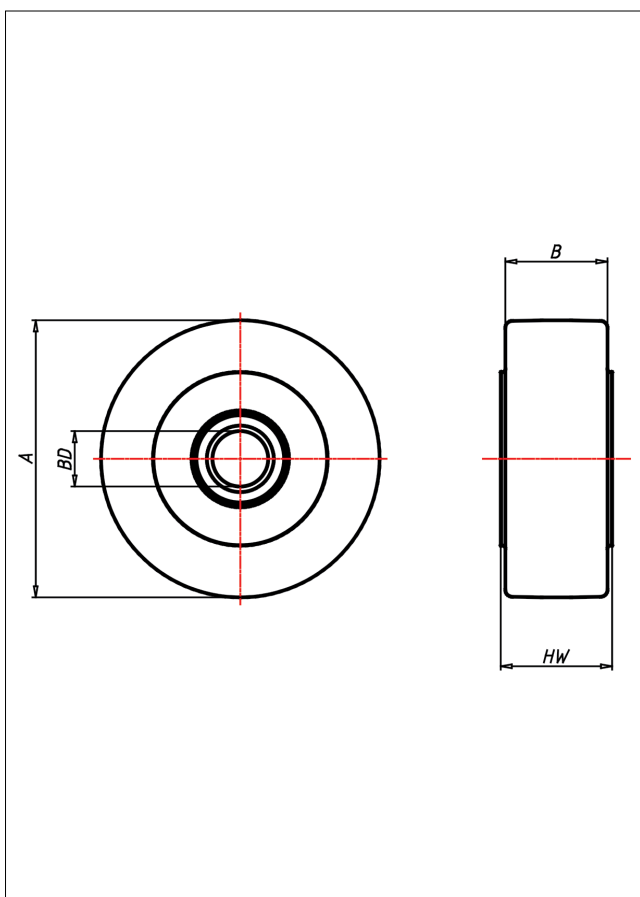

# PE Rad

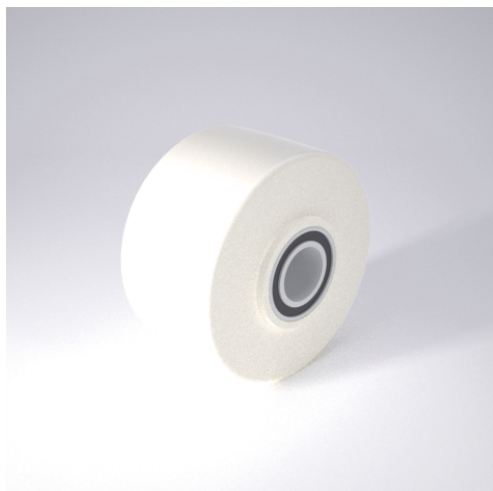

PE



+80 °C  
-40 °C max.  
12000 kg



Vollrad aus Guss-Polyamid 6 - 1. Wahl

- für extra schwere Lasten
- leichter Lauf auf glatten Böden
- stoß- und schlagfest
- hohe Abriebfestigkeit
- leicht zu reinigen
- sehr beständig gegen viele aggressive Medien

## Technische Details

<b>ORDERNO (Artikel-nummer)</b>	81 PEK 25
<b>WDAB (Rad-Ø A x Breite B / mm)</b>	80x50
<b>LC (Tragkraft / kg)</b>	1200
<b>HW (Nabellänge / mm)</b>	70
<b>FL (Einbaulänge / mm)</b>	70
<b>WB (Radlager)</b>	2 Rillen-Kugellager 6205 2RS
<b>BD (Bohrungsdurchmesser / mm)</b>	25