

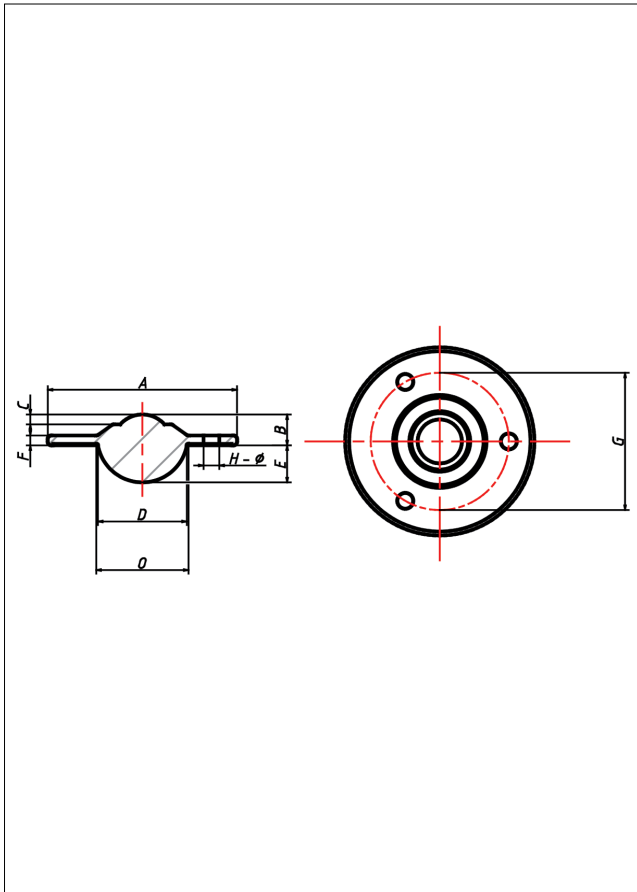

A-Flange

Kugelrollen - Flansch



A-Flange Kugelrollen-Flansch

+70 °C
-30 °C
max. 340 kg



Technische Details

ORDERNO (Artikel-nummer)	A1008-13
BALL (Kugel-Ø / mm)	25
NOH (Loch-anzahl)	3
FH (Ausführung Gehäuse)	Stahl verzinkt
FB (Ausführung Kugeln)	verzinkt
LCU (Tragkraft up / kg)	55
LCD (Tragkraft down / kg)	25
A (/ mm)	73
B (/ mm)	14.2
C (/ mm)	6.3
D (/ mm)	37.2
E (/ mm)	15.8