

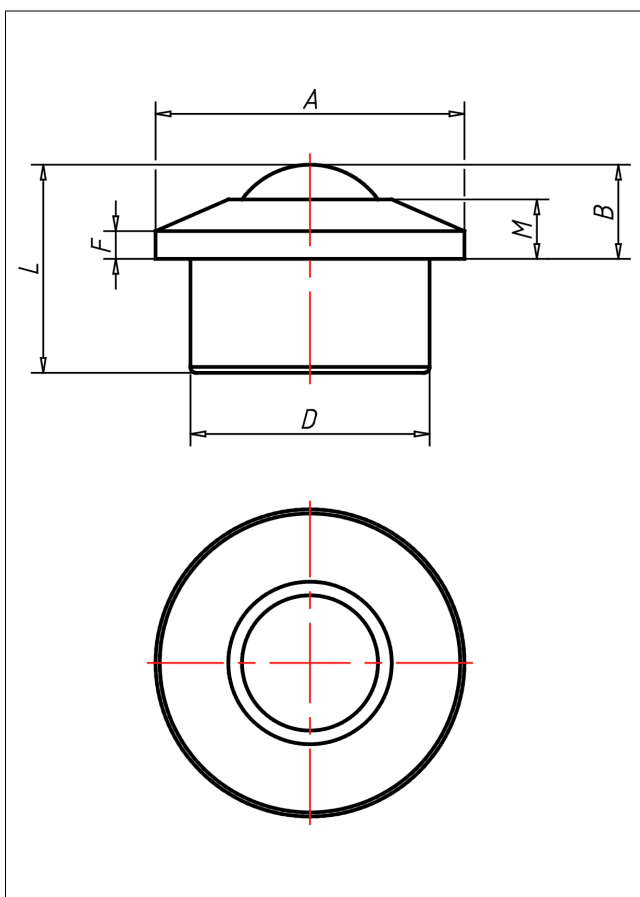

A5 EURO Kugelrollen

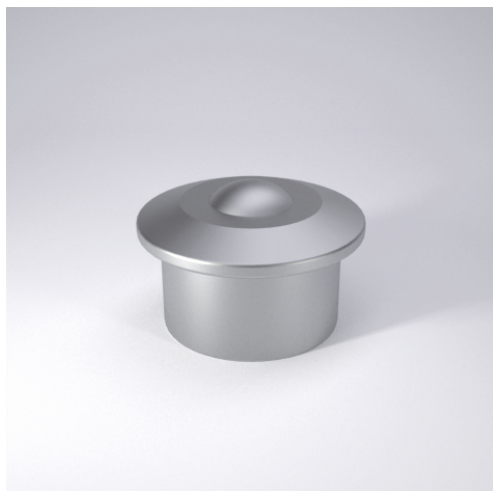

A5 EURO Kugelrollen

+70 °C
-30 °C max.
kg 160 kg

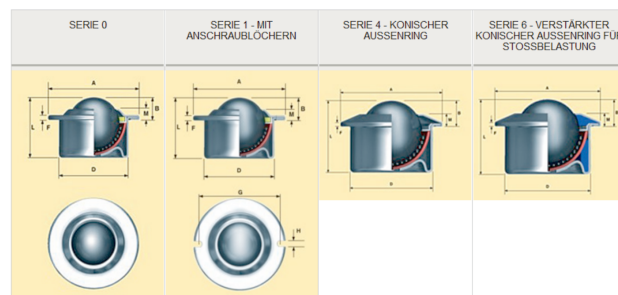

Technische Details

ORDERNO (Artikel-nummer)	A522-6-13
SER (Serie)	6
BALL (Kugel-Ø / mm)	22
FH (Ausführung Gehäuse)	Stahl verzinkt
FB (Ausführung Kugeln)	verzinkt
LC (Tragkraft / kg)	160
A (/ mm)	45
B (/ mm)	9.8
D (/ mm)	36
F (/ mm)	2.8
G (/ mm)	-
H (/ mm)	-