

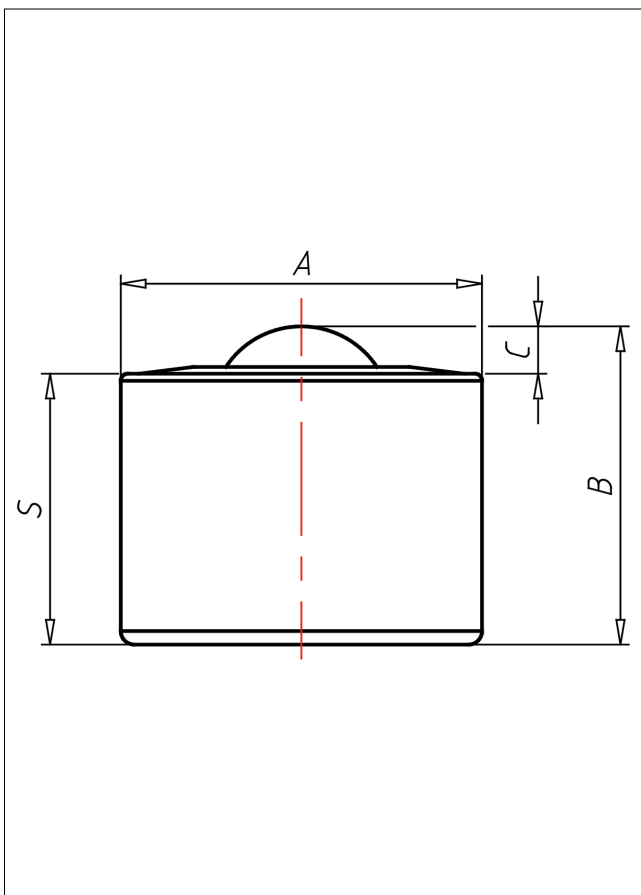

A HI-TECH

Doppelt gedichtet



A HI-TECH doppelt gedichtet

+100 °C
-30 °C max. 320 kg

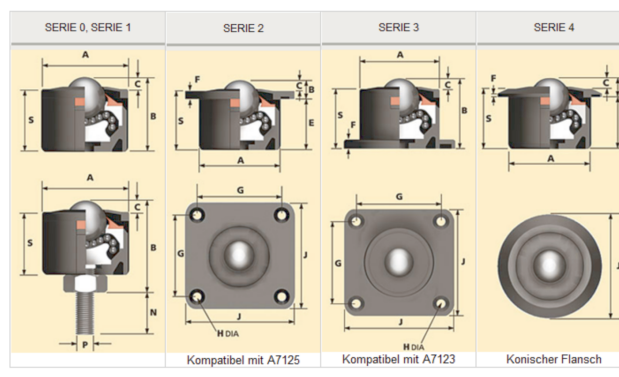

Technische Details

ORDERNO (Artikel-nummer)	A6025-0-13
BALL (Kugel-Ø / mm)	25.4
SER (Serie)	0
FH (Ausführung Gehäuse)	PA-6 Glasfaserverstärkt
FB (Ausführung Kugeln)	Carbon-Stahl
LC (Tragkraft / kg)	320
A (/ mm)	50.8
B (/ mm)	45
C (/ mm)	6.7
E (/ mm)	-
F (/ mm)	-
G (/ mm)	-