

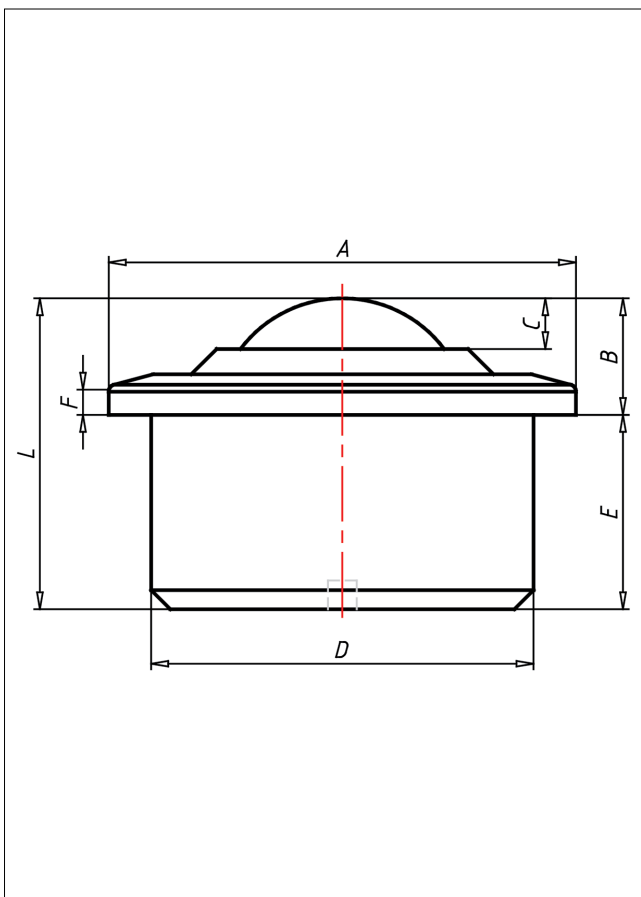

A8

Kugelrollen - Schwerlast



A8 Kugelrollen Schwerlast

+70 °C
-30 °C max.
4000 kg

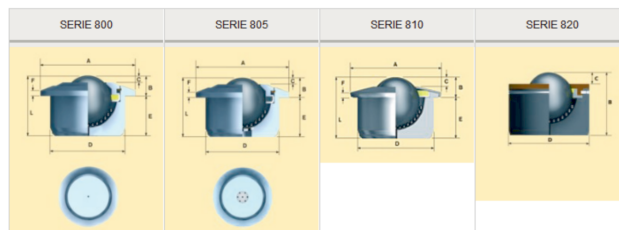

Technische Details

ORDERNO (Artikel-nummer)	A800-60-15
BALL (Kugel-Ø / mm)	60
SER (Serie)	800
FH (Ausführung Gehäuse)	Edelstahl
FB (Ausführung Kugeln)	Edelstahl
LC (Tragkraft / kg)	1000
A (/ mm)	117
B (/ mm)	29.5
C (/ mm)	17
D (/ mm)	100
E (/ mm)	48.0
F (/ mm)	5.0