

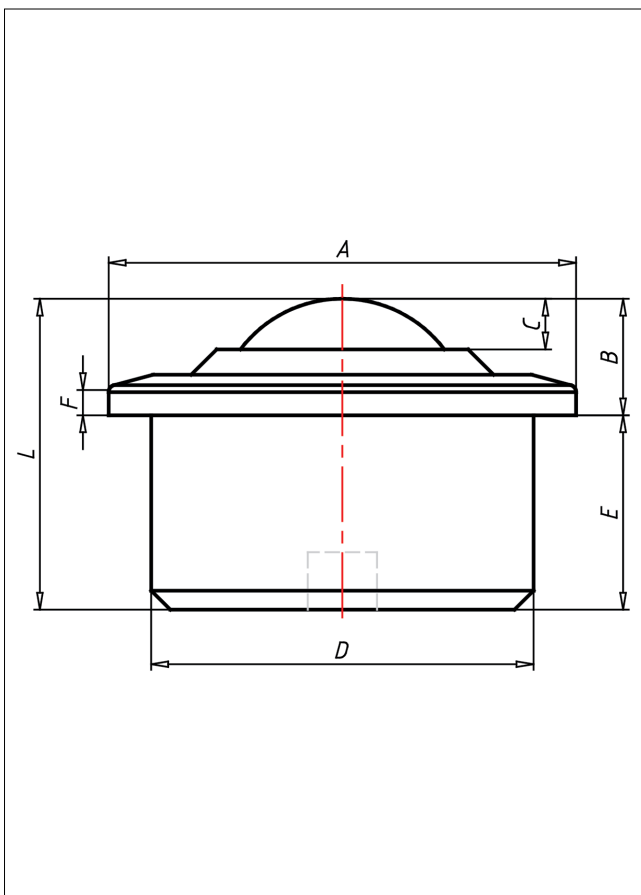

A8

Kugelrollen - Schwerlast



A8 Kugelrollen Schwerlast

+70 °C
-30 °C max.
4000 kg

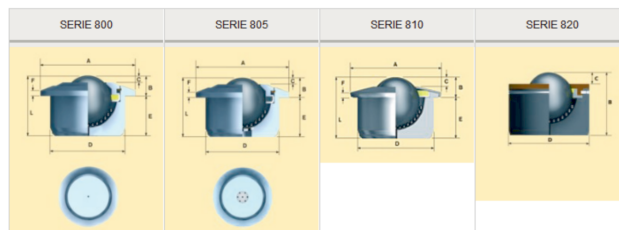

Technische Details

ORDERNO (Artikel-nummer)	A805-30-13
BALL (Kugel-Ø / mm)	30
SER (Serie)	805
FH (Ausführung Gehäuse)	Stahl verzinkt
FB (Ausführung Kugeln)	verzinkt
LC (Tragkraft / kg)	350
A (/ mm)	55
B (/ mm)	13.8
C (/ mm)	6
D (/ mm)	45
E (/ mm)	23.0
F (/ mm)	3.4